

TLC227x-Q1, TLC227xA-Q1 Advanced LinCMOS™ RAIL-TO-RAIL OPERATIONAL AMPLIFIERS

SGLS007B – FEBRUARY 2003 – REVISED OCTOBER 2003

- Qualification in Accordance With AEC-Q100†
- Qualified for Automotive Applications
- Customer-Specific Configuration Control Can Be Supported Along With Major-Change Approval
- ESD Protection Exceeds 2000 V Per MIL-STD-883, Method 3015; Exceeds 100 V Machine Model (C = 200 pF, R = 0); Exceeds 1500 V Charged Device Model
- Output Swing Includes Both Supply Rails
- Low Noise . . . 9 nV/√Hz Typ at f = 1 kHz
- Low Input Bias Current . . . 1 pA Typ
- Fully Specified for Both Single-Supply and Split-Supply Operation
- Common-Mode Input Voltage Range Includes Negative Rail
- High-Gain Bandwidth . . . 2.2 MHz Typ
- High Slew Rate . . . 3.6 V/μs Typ
- Low Input Offset Voltage 950 μV Max at T_A = 25°C
- Macromodel Included
- Performance Upgrades for the TS272, TS274, TLC272, and TLC274

† Contact factory for details. Q100 qualification data available on request.

description

The TLC2272 and TLC2274 are dual and quadruple operational amplifiers from Texas Instruments. Both devices exhibit rail-to-rail output performance for increased dynamic range in single- or split-supply applications. The TLC227x family offers 2 MHz of bandwidth and 3 V/μs of slew rate for higher speed applications. These devices offer comparable ac performance while having better noise, input offset voltage, and power dissipation than existing CMOS operational amplifiers. The TLC227x has a noise voltage of 9 nV/√Hz, two times lower than competitive solutions.

The TLC227x, exhibiting high input impedance and low noise, is excellent for small-signal conditioning for high-impedance sources, such as piezoelectric transducers. Because of the micro-power dissipation levels, these devices work well in hand-held monitoring and remote-sensing applications. In addition, the rail-to-rail output feature, with single- or split-supplies, makes this family a great choice when interfacing with analog-to-digital converters (ADCs). For precision applications, the TLC227xA family is available with a maximum input offset voltage of 950 μV. This family is fully characterized at 5 V and ±5 V.

The TLC2272/4 also makes great upgrades to the TLC272/4 or TS272/4 in standard designs. They offer increased output dynamic range, lower noise voltage, and lower input offset voltage. This enhanced feature set allows them to be used in a wider range of applications. For applications that require higher output drive and wider input voltage range, see the TLV2432 and TLV2442 devices.

MAXIMUM PEAK-TO-PEAK OUTPUT VOLTAGE
vs
SUPPLY VOLTAGE

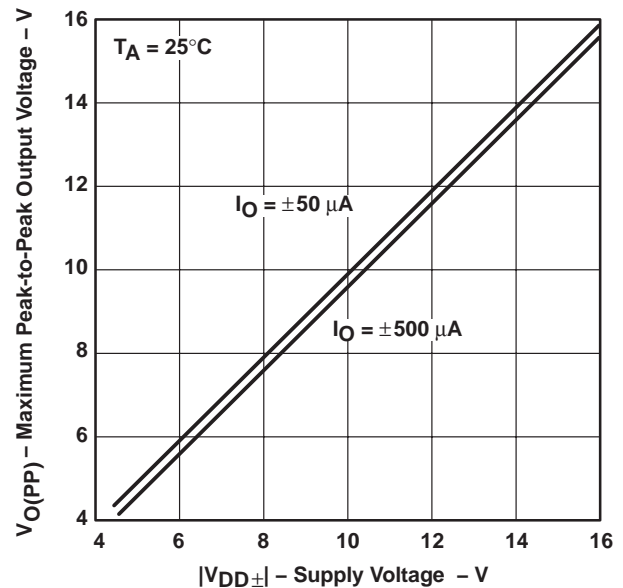

Please be aware that an important notice concerning availability, standard warranty, and use in critical applications of Texas Instruments semiconductor products and disclaimers thereto appears at the end of this data sheet.

Advanced LinCMOS is a trademark of Texas Instruments.

PRODUCTION DATA information is current as of publication date. Products conform to specifications per the terms of Texas Instruments standard warranty. Production processing does not necessarily include testing of all parameters.



POST OFFICE BOX 655303 • DALLAS, TEXAS 75265

Copyright © 2003, Texas Instruments Incorporated

TLC227x-Q1, TLC227xA-Q1
Advanced LinCMOS™ RAIL-TO-RAIL
OPERATIONAL AMPLIFIERS

SGLS007B – FEBRUARY 2003 – REVISED OCTOBER 2003

AVAILABLE OPTIONS

T _A	V _{IO} max At 25°C	PACKAGED DEVICES	
		SMALL OUTLINE (D)	TSSOP (PW)
-40°C to 125°C	950 μV 2.5 mV	TLC2272AQDRQ1 TLC2272QDRQ1	TLC2272AQPWRQ1 TLC2272QPWRQ1
-40°C to 125°C	950 μV 2.5 mV	TLC2274AQDRQ1 TLC2274QDRQ1	TLC2274AQPWRQ1 TLC2274QPWRQ1

TLC2272
D OR PW PACKAGE
(TOP VIEW)

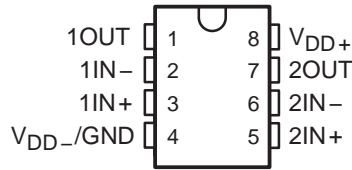

TLC2274
D OR PW PACKAGE
(TOP VIEW)

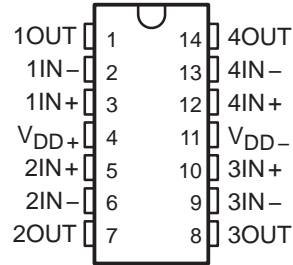

TLC227x-Q1, TLC227xA-Q1
**Advanced LinCMOS™ RAIL-TO-RAIL
 OPERATIONAL AMPLIFIERS**

SGLS007B – FEBRUARY 2003 – REVISED OCTOBER 2003

equivalent schematic (each amplifier)

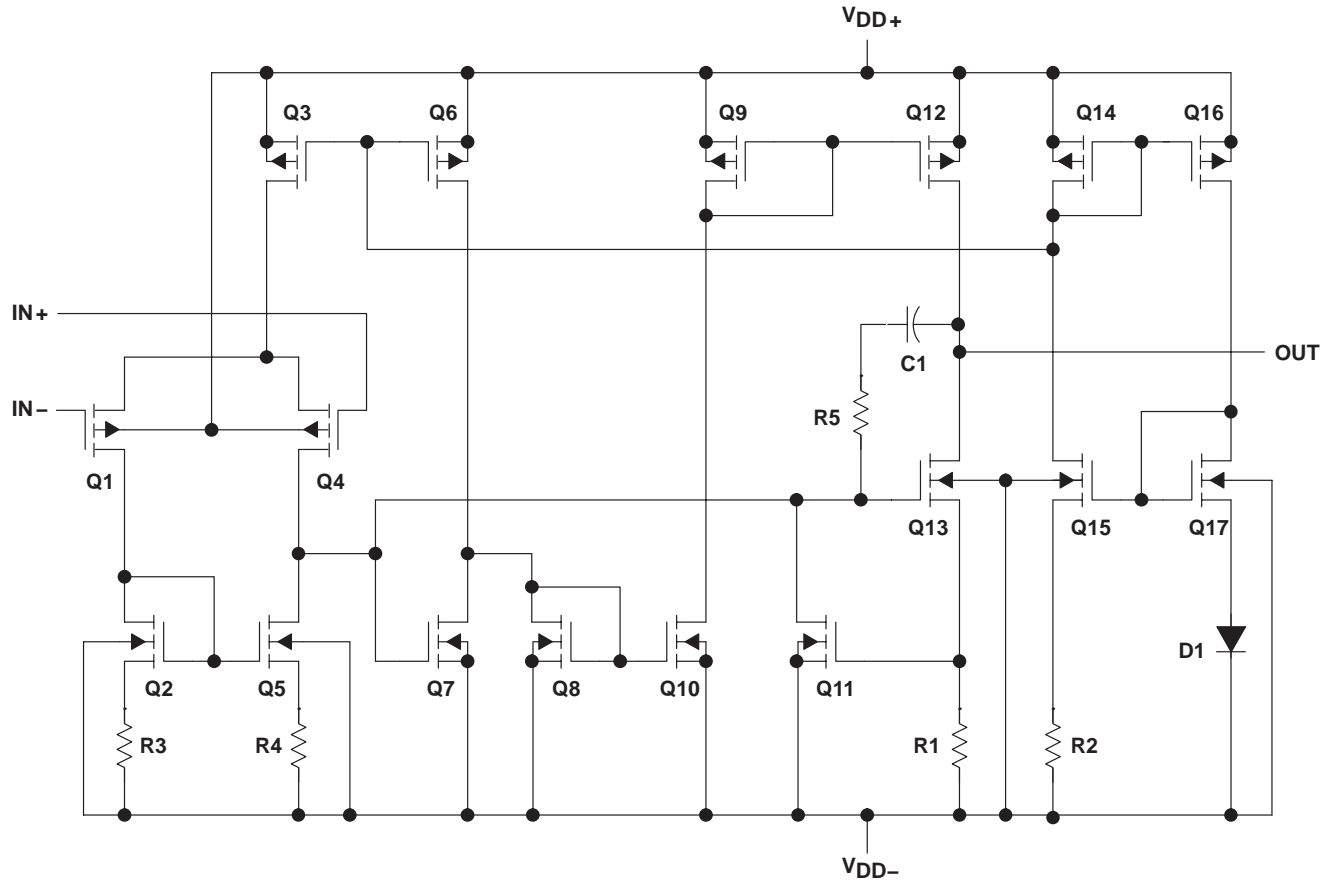

ACTUAL DEVICE COMPONENT COUNT†		
COMPONENT	TLC2272	TLC2274
Transistors	38	76
Resistors	26	52
Diodes	9	18
Capacitors	3	6

† Includes both amplifiers and all ESD, bias, and trim circuitry

TLC227x-Q1, TLC227xA-Q1

Advanced LinCMOS™ RAIL-TO-RAIL OPERATIONAL AMPLIFIERS

SGLS007B – FEBRUARY 2003 – REVISED OCTOBER 2003

absolute maximum ratings over operating free-air temperature range (unless otherwise noted)†

Supply voltage, V_{DD+} (see Note 1)	8 V
Supply voltage, V_{DD-} (see Note 1)	-8 V
Differential input voltage, V_{ID} (see Note 2)	± 16 V
Input voltage range, V_I (any input, see Note 1)	$V_{DD-} - 0.3$ V to V_{DD+}
Input current, I_I (any input)	± 5 mA
Output current, I_O	± 50 mA
Total current into V_{DD+}	± 50 mA
Total current out of V_{DD-}	± 50 mA
Duration of short-circuit current at (or below) 25°C (see Note 3)	unlimited
Continuous total dissipation	See Dissipation Rating Table
Operating free-air temperature range, T_A	-40°C to 125°C
Storage temperature range	-65°C to 150°C
Lead temperature 1,6 mm (1/16 inch) from case for 10 seconds: D or PW package	260°C

† Stresses beyond those listed under “absolute maximum ratings” may cause permanent damage to the device. These are stress ratings only, and functional operation of the device at these or any other conditions beyond those indicated under “recommended operating conditions” is not implied. Exposure to absolute-maximum-rated conditions for extended periods may affect device reliability.

- NOTES:
1. All voltage values, except differential voltages, are with respect to the midpoint between V_{DD+} and V_{DD-} .
 2. Differential voltages are at $IN+$ with respect to $IN-$. Excessive current will flow if input is brought below $V_{DD-} - 0.3$ V.
 3. The output may be shorted to either supply. Temperature and/or supply voltages must be limited to ensure that the maximum dissipation rating is not exceeded.

DISSIPATION RATING TABLE

PACKAGE	$T_A \leq 25^\circ\text{C}$ POWER RATING	DERATING FACTOR ABOVE $T_A = 25^\circ\text{C}$	$T_A = 70^\circ\text{C}$ POWER RATING	$T_A = 85^\circ\text{C}$ POWER RATING	$T_A = 125^\circ\text{C}$ POWER RATING
D-8	725 mW	5.8 mW/°C	464 mW	337 mW	145 mW
D-14	950 mW	7.6 mW/°C	608 mW	494 mW	190 mW
PW-8	525 mW	4.2 mW/°C	336 mW	273 mW	105 mW
PW-14	700 mW	5.6 mW/°C	448 mW	364 mW	—

recommended operating conditions

	MIN	MAX	UNIT
Supply voltage, $V_{DD\pm}$	± 2.2	± 8	V
Input voltage, V_I	V_{DD-}	$V_{DD+} - 1.5$	V
Common-mode input voltage, V_{IC}	V_{DD-}	$V_{DD+} - 1.5$	V
Operating free-air temperature, T_A	-40	125	°C



TLC227x-Q1, TLC227xA-Q1
Advanced LinCMOS™ RAIL-TO-RAIL
OPERATIONAL AMPLIFIERS

SGLS007B – FEBRUARY 2003 – REVISED OCTOBER 2003

TLC2272Q electrical characteristics at specified free-air temperature, $V_{DD} = 5\text{ V}$ (unless otherwise noted)

PARAMETER	TEST CONDITIONS	T_A †	TLC2272Q			TLC2272AQ			UNIT
			MIN	TYP	MAX	MIN	TYP	MAX	
V_{IO} Input offset voltage	$V_{IC} = 0\text{ V},$ $V_O = 0\text{ V},$ $V_{DD\pm} = \pm 2.5\text{ V},$ $R_S = 50\ \Omega$	25°C	300	2500		300	950	μV	
		Full range			3000		1500		
α_{VIO} Temperature coefficient of input offset voltage		25°C to 125°C	2			2		$\mu\text{V}/^\circ\text{C}$	
Input offset voltage long-term drift (see Note 4)		25°C	0.002			0.002		$\mu\text{V}/\text{mo}$	
I_{IO} Input offset current		25°C	0.5	60		0.5	60	pA	
		Full range			800		800		
I_{IB} Input bias current	25°C	1	60		1	60	pA		
	Full range			800		800			
V_{ICR} Common-mode input voltage	$R_S = 50\ \Omega,$ $ V_{IO} \leq 5\text{ mV}$	25°C	0 to 4	-0.3 to 4.2		0 to 4	-0.3 to 4.2	V	
		Full range	0 to 3.5			0 to 3.5			
V_{OH} High-level output voltage	$I_{OH} = -20\ \mu\text{A}$ $I_{OH} = -200\ \mu\text{A}$ $I_{OH} = -1\text{ mA}$	25°C	4.99			4.99	V		
		25°C	4.85	4.93		4.85		4.93	
		Full range	4.85			4.85			
		25°C	4.25	4.65		4.25		4.65	
V_{OL} Low-level output voltage	$V_{IC} = 2.5\text{ V},$ $I_{OL} = 50\ \mu\text{A}$ $V_{IC} = 2.5\text{ V},$ $I_{OL} = 500\ \mu\text{A}$ $V_{IC} = 2.5\text{ V},$ $I_{OL} = 5\text{ mA}$	25°C	0.01			0.01	V		
		25°C	0.09	0.15		0.09		0.15	
		Full range			0.15			0.15	
		25°C	0.9	1.5		0.9		1.5	
A_{VD} Large-signal differential voltage amplification	$V_{IC} = 2.5\text{ V},$ $V_O = 1\text{ V to }4\text{ V}$	$R_L = 10\text{ k}\Omega$ ‡	25°C	10	35		10	35	V/mV
			Full range	10			10		
		$R_L = 1\text{ m}\Omega$ ‡	25°C	175			175		
r_{id} Differential input resistance		25°C	10^{12}			10^{12}	Ω		
r_i Common-mode input resistance		25°C	10^{12}			10^{12}	Ω		
c_i Common-mode input capacitance	$f = 10\text{ kHz},$ P package	25°C	8			8	pF		
z_o Closed-loop output impedance	$f = 1\text{ MHz},$ $A_V = 10$	25°C	140			140	Ω		
CMRR Common-mode rejection ratio	$V_{IC} = 0\text{ V to }2.7\text{ V},$ $V_O = 2.5\text{ V},$ $R_S = 50\ \Omega$	25°C	70	75		70	75	dB	
		Full range	70			70			
k_{SVR} Supply-voltage rejection ratio ($\Delta V_{DD}/\Delta V_{IO}$)	$V_{DD} = 4.4\text{ V to }16\text{ V},$ $V_{IC} = V_{DD}/2,$ No load	25°C	80	95		80	95	dB	
		Full range	80			80			
I_{DD} Supply current	$V_O = 2.5\text{ V},$ No load	25°C	2.2	3		2.2	3	mA	
		Full range			3		3		

† Full range is -40°C to 125°C for Q level part.

‡ Referenced to 2.5 V

NOTE 4: Typical values are based on the input offset voltage shift observed through 168 hours of operating life test at $T_A = 150^\circ\text{C}$ extrapolated to $T_A = 25^\circ\text{C}$ using the Arrhenius equation and assuming an activation energy of 0.96 eV.



TLC227x-Q1, TLC227xA-Q1
Advanced LinCMOS™ RAIL-TO-RAIL
OPERATIONAL AMPLIFIERS

SGLS007B – FEBRUARY 2003 – REVISED OCTOBER 2003

TLC2272Q operating characteristics at specified free-air temperature, $V_{DD} = 5\text{ V}$

PARAMETER	TEST CONDITIONS	T_A †	TLC2272Q			TLC2272AQ			UNIT
			MIN	TYP	MAX	MIN	TYP	MAX	
SR	Slew rate at unity gain $V_O = 1.25\text{ V to }2.75\text{ V}$, $R_L = 10\text{ k}\Omega$ ‡, $C_L = 100\text{ pF}$ ‡	25°C	2.3	3.6		2.3	3.6	V/ μs	
		Full range	1.7			1.7			
V_n	Equivalent input noise voltage $f = 10\text{ Hz}$ $f = 1\text{ kHz}$	25°C		50			50	nV/ $\sqrt{\text{Hz}}$	
		25°C		9			9		
V_{NPP}	Peak-to-peak equivalent input noise voltage $f = 0.1\text{ Hz to }1\text{ Hz}$ $f = 0.1\text{ Hz to }10\text{ Hz}$	25°C		1			1	μV	
		25°C		1.4			1.4		
I_n	Equivalent input noise current	25°C		0.6			0.6	fA/ $\sqrt{\text{Hz}}$	
THD + N	Total harmonic distortion plus noise $V_O = 0.5\text{ V to }2.5\text{ V}$, $f = 20\text{ kHz}$, $R_L = 10\text{ k}\Omega$ ‡	25°C	$A_V = 1$	0.0013%			0.0013%		
			$A_V = 10$	0.004%			0.004%		
			$A_V = 100$	0.03%			0.03%		
	Gain-bandwidth product $f = 10\text{ kHz}$, $R_L = 10\text{ k}\Omega$ ‡, $C_L = 100\text{ pF}$ ‡	25°C		2.18			2.18	MHz	
BOM	Maximum output-swing bandwidth $V_{O(PP)} = 2\text{ V}$, $R_L = 10\text{ k}\Omega$ ‡, $A_V = 1$, $C_L = 100\text{ pF}$ ‡	25°C		1			1	MHz	
t_s	Settling time $A_V = -1$, Step = 0.5 V to 2.5 V, $R_L = 10\text{ k}\Omega$ ‡, $C_L = 100\text{ pF}$ ‡	25°C	To 0.1%	1.5			1.5	μs	
			To 0.01%	2.6			2.6		
ϕ_m	Phase margin at unity gain $R_L = 10\text{ k}\Omega$ ‡, $C_L = 100\text{ pF}$ ‡	25°C		50°			50°		
	Gain margin	25°C		10			10	dB	

† Full range is -40°C to 125°C for Q level part.

‡ Referenced to 2.5 V



TLC227x-Q1, TLC227xA-Q1
Advanced LinCMOS™ RAIL-TO-RAIL
OPERATIONAL AMPLIFIERS

SGLS007B – FEBRUARY 2003 – REVISED OCTOBER 2003

TLC2272Q electrical characteristics at specified free-air temperature, $V_{DD\pm} = \pm 5\text{ V}$ (unless otherwise noted)

PARAMETER	TEST CONDITIONS	T_A †	TLC2272Q			TLC2272AQ			UNIT
			MIN	TYP	MAX	MIN	TYP	MAX	
V_{IO} Input offset voltage	$V_{IC} = 0\text{ V},$ $R_S = 50\ \Omega$ $V_O = 0\text{ V},$	25°C	300	2500		300	950	μV	
		Full range			3000		1500		
α_{VIO} Temperature coefficient of input offset voltage		25°C to 125°C	2			2		$\mu\text{V}/^\circ\text{C}$	
Input offset voltage long-term drift (see Note 4)		25°C	0.002			0.002		$\mu\text{V}/\text{mo}$	
I_{IO} Input offset current		25°C	0.5	60		0.5	60	pA	
		Full range			800		800		
I_{IB} Input bias current	25°C	1	60		1	60	pA		
	Full range			800		800			
V_{ICR} Common-mode input voltage	$R_S = 50\ \Omega,$ $ V_{IO} \leq 5\text{ mV}$	25°C	-5 to 4	-5.3 to 4.2		-5 to 4	-5.3 to 4.2	V	
		Full range	-5 to 3.5			-5 to 3.5			
V_{OM+} Maximum positive peak output voltage	$I_O = -20\ \mu\text{A}$ $I_O = -200\ \mu\text{A}$ $I_O = -1\text{ mA}$	25°C		4.99			4.99	V	
		25°C	4.85	4.93		4.85	4.93		
		Full range	4.85			4.85			
		25°C	4.25	4.65		4.25	4.65		
V_{OM-} Maximum negative peak output voltage	$V_{IC} = 0\text{ V},$ $I_O = 50\ \mu\text{A}$ $V_{IC} = 0\text{ V},$ $I_O = 500\ \mu\text{A}$ $V_{IC} = 0\text{ V},$ $I_O = 5\text{ mA}$	25°C		-4.99			-4.99	V	
		25°C	-4.85	-4.91		-4.85	-4.91		
		Full range	-4.85			-4.85			
		25°C	-3.5	-4.1		-3.5	-4.1		
A_{VD} Large-signal differential voltage amplification	$V_O = \pm 4\text{ V}$ $R_L = 10\ \text{k}\Omega$ $R_L = 1\ \text{m}\Omega$	25°C	20	50		20	50	V/mV	
		Full range	20			20			
		25°C		300			300		
r_{id} Differential input resistance		25°C		10^{12}			10^{12}	Ω	
r_i Common-mode input resistance		25°C		10^{12}			10^{12}	Ω	
c_i Common-mode input capacitance	$f = 10\ \text{kHz},$ P package	25°C		8			8	pF	
z_o Closed-loop output impedance	$f = 1\ \text{MHz},$ $A_V = 10$	25°C		130			130	Ω	
CMRR Common-mode rejection ratio	$V_{IC} = -5\text{ V to } 2.7\text{ V},$ $V_O = 0\text{ V},$ $R_S = 50\ \Omega$	25°C	75	80		75	80	dB	
		Full range	75			75			
k_{SVR} Supply-voltage rejection ratio ($\Delta V_{DD\pm}/\Delta V_{IO}$)	$V_{DD} = \pm 2.2\text{ V to } \pm 8\text{ V},$ $V_{IC} = 0\text{ V},$ No load	25°C	80	95		80	95	dB	
		Full range	80			80			
I_{DD} Supply current	$V_O = 2.5\text{ V},$ No load	25°C	2.4	3		2.4	3	mA	
		Full range			3		3		

† Full range is -40°C to 125°C for Q level part.

NOTE 4: Typical values are based on the input offset voltage shift observed through 168 hours of operating life test at $T_A = 150^\circ\text{C}$ extrapolated to $T_A = 25^\circ\text{C}$ using the Arrhenius equation and assuming an activation energy of 0.96 eV.



TLC227x-Q1, TLC227xA-Q1
Advanced LinCMOS™ RAIL-TO-RAIL
OPERATIONAL AMPLIFIERS

SGLS007B – FEBRUARY 2003 – REVISED OCTOBER 2003

TLC2272Q operating characteristics at specified free-air temperature, $V_{DD\pm} = \pm 5\text{ V}$

PARAMETER	TEST CONDITIONS	T_A †	TLC2272Q			TLC2272AQ			UNIT
			MIN	TYP	MAX	MIN	TYP	MAX	
SR	Slew rate at unity gain $V_O = \pm 1\text{ V}$, $C_L = 100\text{ pF}$ $R_L = 10\text{ k}\Omega$	25°C	2.3	3.6		2.3	3.6	V/ μ s	
		Full range	1.7			1.7			
V_n	Equivalent input noise voltage	25°C		50			50	nV/ $\sqrt{\text{Hz}}$	
		25°C		9			9		
V_{NPP}	Peak-to-peak equivalent input noise voltage	25°C		1			1	μ V	
		25°C		1.4			1.4		
I_n	Equivalent input noise current	25°C		0.6			0.6	fA/ $\sqrt{\text{Hz}}$	
THD + N	Total harmonic distortion plus noise $V_O = \pm 2.3\text{ V}$ $R_L = 10\text{ k}\Omega$, $f = 20\text{ kHz}$	25°C		$A_V = 1$	0.0011%		0.0011%		
				$A_V = 10$	0.004%		0.004%		
				$A_V = 100$	0.03%		0.03%		
	Gain-bandwidth product	25°C		2.25			2.25	MHz	
BOM	Maximum output-swing bandwidth $V_{O(PP)} = 4.6\text{ V}$, $R_L = 10\text{ k}\Omega$	25°C		0.54			0.54	MHz	
t_s	Settling time $A_V = -1$, Step = -2.3 V to 2.3 V , $R_L = 10\text{ k}\Omega$, $C_L = 100\text{ pF}$	25°C		To 0.1%	1.5		1.5	μ s	
				To 0.01%	3.2		3.2		
ϕ_m	Phase margin at unity gain	25°C		52°			52°		
	Gain margin	25°C		10			10	dB	

† Full range is -40°C to 125°C for Q level part.

TLC2274Q electrical characteristics at specified free-air temperature, $V_{DD} = 5\text{ V}$ (unless otherwise noted)

PARAMETER	TEST CONDITIONS	T_A †	TLC2274Q			TLC2274AQ			UNIT
			MIN	TYP	MAX	MIN	TYP	MAX	
V_{IO} Input offset voltage	$V_{DD} \pm \pm 2.5\text{ V}, V_{IC} = 0\text{ V}, V_O = 0\text{ V}, R_S = 50\ \Omega$	25°C	300	2500		300	950		μV
		Full range			3000		1500		
α_{VIO} Temperature coefficient of input offset voltage		25°C to 125°C	2			2			$\mu\text{V}/^\circ\text{C}$
Input offset voltage long-term drift (see Note 4)		25°C	0.002			0.002			$\mu\text{V}/\text{mo}$
I_{IO} Input offset current		25°C	0.5	60		0.5	60		pA
		Full range			800		800		
I_{IB} Input bias current		25°C	1		60	1		60	pA
		Full range			800			800	
V_{ICR} Common-mode input voltage	$R_S = 50\ \Omega, V_{IO} \leq 5\text{ mV}$	25°C	0 to 4	-0.3 to 4.2	0 to 4	-0.3 to 4.2		V	
		Full range	0 to 3.5		0 to 3.5				
V_{OH} High-level output voltage	$I_{OH} = -20\ \mu\text{A}$	25°C	4.99		4.99			V	
		25°C	4.85	4.93	4.85	4.93			
		Full range	4.85		4.85				
		25°C	4.25	4.65	4.25	4.65			
V_{OL} Low-level output voltage	$V_{IC} = 2.5\text{ V}, I_{OL} = 50\ \mu\text{A}$	25°C	0.01		0.01			V	
		25°C	0.09	0.15	0.09	0.15			
		Full range	0.15		0.15				
		25°C	0.9	1.5	0.9	1.5			
V_{OL} Low-level output voltage	$V_{IC} = 2.5\text{ V}, I_{OL} = 5\text{ mA}$	25°C	0.01		0.01			V	
		25°C	0.09	0.15	0.09	0.15			
		Full range	0.15		0.15				
		25°C	0.9	1.5	0.9	1.5			
A_{VD} Large-signal differential voltage amplification	$V_{IC} = 2.5\text{ V}, V_O = 1\text{ V to }4\text{ V}$	$R_L = 10\text{ k}\Omega$ ‡	25°C	10	35	10	35	V/mV	
			Full range	10		10			
		$R_L = 1\text{ M}\Omega$ ‡	25°C	175		175			
r_{id} Differential input resistance		25°C	10^{12}			10^{12}		Ω	
r_i Common-mode input resistance		25°C	10^{12}			10^{12}		Ω	
c_i Common-mode input capacitance	$f = 10\text{ kHz}, \text{ N package}$	25°C	8			8		pF	
z_o Closed-loop output impedance	$f = 1\text{ MHz}, A_V = 10$	25°C	140			140		Ω	
CMRR Common-mode rejection ratio	$V_{IC} = 0\text{ V to }2.7\text{ V}, V_O = 2.5\text{ V}, R_S = 50\ \Omega$	25°C	70	75	70	75	dB		
		Full range	70		70				
k_{SVR} Supply-voltage rejection ratio ($\Delta V_{DD}/\Delta V_{IO}$)	$V_{DD} = 4.4\text{ V to }16\text{ V}, V_{IC} = V_{DD}/2, \text{ No load}$	25°C	80	95	80	95	dB		
		Full range	80		80				
I_{DD} Supply current	$V_O = 2.5\text{ V}, \text{ No load}$	25°C	4.4	6	4.4	6	mA		
		Full range	6		6				

† Full range is -40°C to 125°C for Q level part.

‡ Referenced to 2.5 V

NOTE 4: Typical values are based on the input offset voltage shift observed through 168 hours of operating life test at $T_A = 150^\circ\text{C}$ extrapolated to $T_A = 25^\circ\text{C}$ using the Arrhenius equation and assuming an activation energy of 0.96 eV.

TLC227x-Q1, TLC227xA-Q1
Advanced LinCMOS™ RAIL-TO-RAIL
OPERATIONAL AMPLIFIERS

SGLS007B – FEBRUARY 2003 – REVISED OCTOBER 2003

TLC2274Q operating characteristics at specified free-air temperature, $V_{DD} = 5\text{ V}$

PARAMETER	TEST CONDITIONS	T_A †	TLC2274Q			TLC2274AQ			UNIT
			MIN	TYP	MAX	MIN	TYP	MAX	
SR	Slew rate at unity gain $V_O = 0.5\text{ V to }2.5\text{ V},$ $R_L = 10\text{ k}\Omega^\ddagger,$ $C_L = 100\text{ pF}^\ddagger$	25°C	2.3	3.6		2.3	3.6	V/ μs	
		Full range	1.7			1.7			
V_n	Equivalent input noise voltage	f = 10 Hz		50			50	nV/ $\sqrt{\text{Hz}}$	
		f = 1 kHz	25°C		9		9		
$V_{N(PP)}$	Peak-to-peak equivalent input noise voltage	f = 0.1 Hz to 1 Hz	25°C		1		1	μV	
		f = 0.1 Hz to 10 Hz	25°C		1.4		1.4		
I_n	Equivalent input noise current	25°C		0.6			0.6	fA/ $\sqrt{\text{Hz}}$	
THD + N	Total harmonic distortion plus noise $V_O = 0.5\text{ V to }2.5\text{ V},$ f = 20 kHz, $R_L = 10\text{ k}\Omega^\ddagger$	$A_V = 1$	25°C	0.0013%		0.0013%			
		$A_V = 10$		0.004%		0.004%			
		$A_V = 100$		0.03%		0.03%			
	Gain-bandwidth product	f = 10 kHz, $C_L = 100\text{ pF}^\ddagger$	25°C		2.18		2.18	MHz	
BOM	Maximum output-swing bandwidth	$V_{O(PP)} = 2\text{ V},$ $R_L = 10\text{ k}\Omega^\ddagger,$ $A_V = 1,$ $C_L = 100\text{ pF}^\ddagger$	25°C		1		1	MHz	
t_s	Settling time	$A_V = -1,$ Step = 0.5 V to 2.5 V, $R_L = 10\text{ k}\Omega^\ddagger,$ $C_L = 100\text{ pF}^\ddagger$	To 0.1%	25°C	1.5		1.5		μs
			To 0.01%		2.6		2.6		
ϕ_m	Phase margin at unity gain	$R_L = 10\text{ k}\Omega^\ddagger,$ $C_L = 100\text{ pF}^\ddagger$	25°C		50°		50°		
	Gain margin		25°C		10		10	dB	

† Full range is -40°C to 125°C for Q level part.

‡ Referenced to 2.5 V



TLC2274Q electrical characteristics at specified free-air temperature, $V_{DD\pm} = \pm 5\text{ V}$ (unless otherwise noted)

PARAMETER	TEST CONDITIONS	T_A †	TLC2274Q			TLC2274AQ			UNIT	
			MIN	TYP	MAX	MIN	TYP	MAX		
V_{IO} Input offset voltage	$V_{IC} = 0\text{ V}, V_O = 0\text{ V}, R_S = 50\ \Omega$	25°C	300	2500		300	950	μV		
		Full range			3000		1500			
αV_{IO} Temperature coefficient of input offset voltage		25°C to 125°C	2			2			$\mu\text{V}/^\circ\text{C}$	
Input offset voltage long-term drift (see Note 4)		25°C	0.002			0.002			$\mu\text{V}/\text{mo}$	
I_{IO} Input offset current		25°C	0.5	60		0.5	60	pA		
		Full range			800		800			
I_{IB} Input bias current		25°C	1	60		1	60	pA		
		Full range			800		800			
V_{ICR} Common-mode input voltage	$R_S = 50\ \Omega, V_{IO} \leq 5\text{ mV}$	25°C	-5 to 4	-5.3 to 4.2		-5 to 4	-5.3 to 4.2	V		
		Full range	-5 to 3.5			-5 to 3.5				
V_{OM+} Maximum positive peak output voltage	$I_O = -20\ \mu\text{A}$	25°C	4.99		4.99		V			
		25°C	4.85	4.93	4.85	4.93				
		Full range	4.85		4.85					
		25°C	4.25	4.65	4.25	4.65				
V_{OM-} Maximum negative peak output voltage	$I_O = -1\text{ mA}$	25°C	-4.99		-4.99		V			
		25°C	-4.85	-4.91	-4.85	-4.91				
		Full range	-4.85		-4.85					
		25°C	-3.5	-4.1	-3.5	-4.1				
V_{AVD} Large-signal differential voltage amplification	$V_O = \pm 4\text{ V}$	$R_L = 10\text{ k}\Omega$	25°C	20	50	20	50	V/mV		
			Full range	20		20				
		$R_L = 1\text{ M}\Omega$	25°C	300			300			
			Full range	300			300			
r_{id} Differential input resistance		25°C	10^{12}			10^{12}			Ω	
r_i Common-mode input resistance		25°C	10^{12}			10^{12}			Ω	
c_i Common-mode input capacitance	$f = 10\text{ kHz}, \text{ N package}$	25°C	8			8			pF	
z_o Closed-loop output impedance	$f = 1\text{ MHz}, A_V = 10$	25°C	130			130			Ω	
CMRR Common-mode rejection ratio	$V_{IC} = -5\text{ V to } 2.7\text{ V}$ $V_O = 0\text{ V}, R_S = 50\ \Omega$	25°C	75	80		75	80	dB		
		Full range	75			75				
k_{SVR} Supply-voltage rejection ratio ($\Delta V_{DD\pm}/\Delta V_{IO}$)	$V_{DD\pm} = \pm 2.2\text{ V to } \pm 8\text{ V}, V_{IC} = 0\text{ V}, \text{ No load}$	25°C	80	95		80	95	dB		
		Full range	80			80				
I_{DD} Supply current	$V_O = 0\text{ V}, \text{ No load}$	25°C	4.8	6		4.8	6	mA		
		Full range	6			6				

† Full range is -40°C to 125°C for Q level part.

NOTE 4: Typical values are based on the input offset voltage shift observed through 168 hours of operating life test at $T_A = 150^\circ\text{C}$ extrapolated to $T_A = 25^\circ\text{C}$ using the Arrhenius equation and assuming an activation energy of 0.96 eV.

TLC227x-Q1, TLC227xA-Q1
Advanced LinCMOS™ RAIL-TO-RAIL
OPERATIONAL AMPLIFIERS

SGLS007B – FEBRUARY 2003 – REVISED OCTOBER 2003

TLC2274Q operating characteristics at specified free-air temperature, $V_{DD\pm} = \pm 5\text{ V}$

PARAMETER	TEST CONDITIONS	T_A †	TLC2274Q			TLC2274AQ			UNIT
			MIN	TYP	MAX	MIN	TYP	MAX	
SR	Slew rate at unity gain $V_O = \pm 2.3\text{ V}$, $C_L = 100\text{ pF}$, $R_L = 10\text{ k}\Omega$	25°C	2.3	3.6		2.3	3.6	V/ μ s	
		Full range	1.7			1.7			
V_n	Equivalent input noise voltage $f = 10\text{ Hz}$ $f = 1\text{ kHz}$	25°C		50			50	nV/ $\sqrt{\text{Hz}}$	
		25°C		9			9		
$V_{N(PP)}$	Peak-to-peak equivalent input noise voltage $f = 0.1\text{ Hz to }1\text{ Hz}$ $f = 0.1\text{ Hz to }10\text{ Hz}$	25°C		1			1	μ V	
		25°C		1.4			1.4		
I_n	Equivalent input noise current	25°C		0.6			0.6	fA/ $\sqrt{\text{Hz}}$	
THD + N	Total harmonic distortion plus noise $V_O = \pm 2.3\text{ V}$, $R_L = 10\text{ k}\Omega$, $f = 20\text{ kHz}$	$A_V = 1$ $A_V = 10$ $A_V = 100$	25°C		0.0011%		0.0011%		
					0.004%		0.004%		
					0.03%		0.03%		
	Gain-bandwidth product $f = 10\text{ kHz}$, $C_L = 100\text{ pF}$, $R_L = 10\text{ k}\Omega$	25°C		2.25			2.25	MHz	
BOM	Maximum output-swing bandwidth $V_{O(PP)} = 4.6\text{ V}$, $R_L = 10\text{ k}\Omega$, $A_V = 1$, $C_L = 100\text{ pF}$	25°C		0.54			0.54	MHz	
t_s	Settling time $A_V = -1$, Step = $-2.3\text{ V to }2.3\text{ V}$, $R_L = 10\text{ k}\Omega$, $C_L = 100\text{ pF}$	To 0.1%	25°C		1.5		1.5	μ s	
		To 0.01%			3.2		3.2		
ϕ_m	Phase margin at unit gain $R_L = 10\text{ k}\Omega$, $C_L = 100\text{ pF}$	25°C		52°			52°		
		25°C		10			10	dB	

† Full range is -40°C to 125°C for Q level part.

TYPICAL CHARACTERISTICS

Table of Graphs

			FIGURE
V_{IO}	Input offset voltage	Distribution vs Common-mode voltage	1 – 4 5, 6
α_{VIO}	Input offset voltage temperature coefficient	Distribution	7 – 10
I_{IB}/I_{IO}	Input bias and input offset current	vs Free-air temperature	11
V_I	Input voltage	vs Supply voltage vs Free-air temperature	12 13
V_{OH}	High-level output voltage	vs High-level output current	14
V_{OL}	Low-level output voltage	vs Low-level output current	15, 16
V_{OM+}	Maximum positive peak output voltage	vs Output current	17
V_{OM-}	Maximum negative peak output voltage	vs Output current	18
$V_{O(PP)}$	Maximum peak-to-peak output voltage	vs Frequency	19
I_{OS}	Short-circuit output current	vs Supply voltage vs Free-air temperature	20 21
V_O	Output voltage	vs Differential input voltage	22, 23
A_{VD}	Large-signal differential voltage amplification	vs Load resistance	24
	Large-signal differential voltage amplification and phase margin	vs Frequency	25, 26
	Large-signal differential voltage amplification	vs Free-air temperature	27, 28
z_o	Output impedance	vs Frequency	29, 30
CMRR	Common-mode rejection ratio	vs Frequency	31
		vs Free-air temperature	32
k_{SVR}	Supply-voltage rejection ratio	vs Frequency	33, 34
		vs Free-air temperature	35
I_{DD}	Supply current	vs Supply voltage	36, 37
		vs Free-air temperature	38, 39
SR	Slew rate	vs Load capacitance	40
		vs Free-air temperature	41
V_O	Inverting large-signal pulse response		42, 43
	Voltage-follower large-signal pulse response		44, 45
	Inverting small-signal pulse response		46, 47
	Voltage-follower small-signal pulse response		48, 49
V_n	Equivalent input noise voltage	vs Frequency	50, 51
	Noise voltage over a 10-second period		52
	Integrated noise voltage	vs Frequency	53
THD + N	Total harmonic distortion plus noise	vs Frequency	54
	Gain-bandwidth product	vs Supply voltage	55
		vs Free-air temperature	56
ϕ_m	Phase margin	vs Load capacitance	57
	Gain margin	vs Load capacitance	58

NOTE: For all graphs where $V_{DD} = 5\text{ V}$, all loads are referenced to 2.5 V.

TYPICAL CHARACTERISTICS

**DISTRIBUTION OF TLC2272
 INPUT OFFSET VOLTAGE**

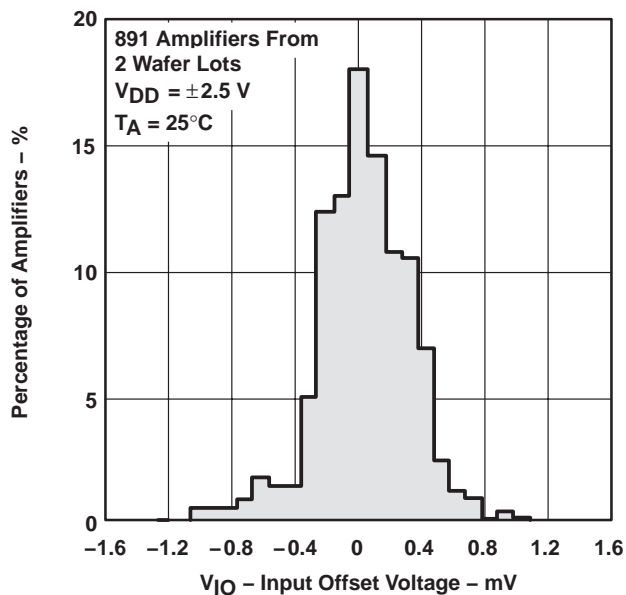

Figure 1

**DISTRIBUTION OF TLC2272
 INPUT OFFSET VOLTAGE**

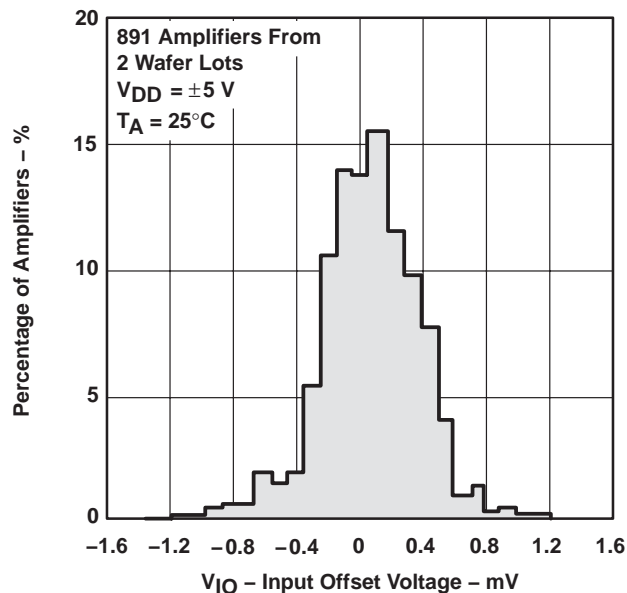

Figure 2

**DISTRIBUTION OF TLC2274
 INPUT OFFSET VOLTAGE**

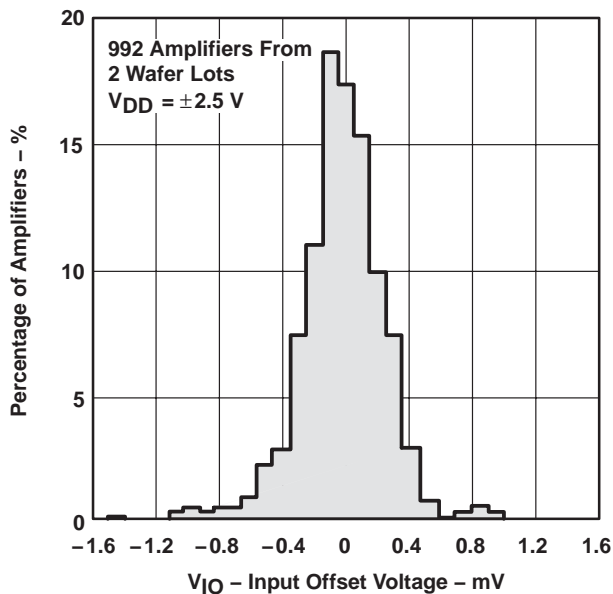

Figure 3

**DISTRIBUTION OF TLC2274
 INPUT OFFSET VOLTAGE**

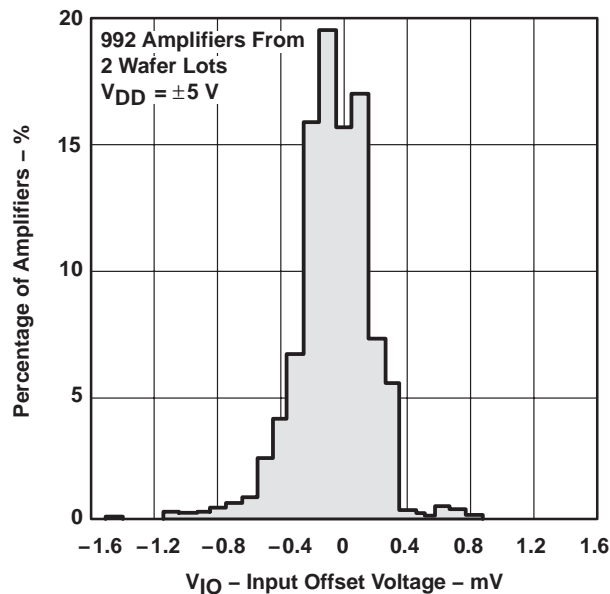

Figure 4

TYPICAL CHARACTERISTICS

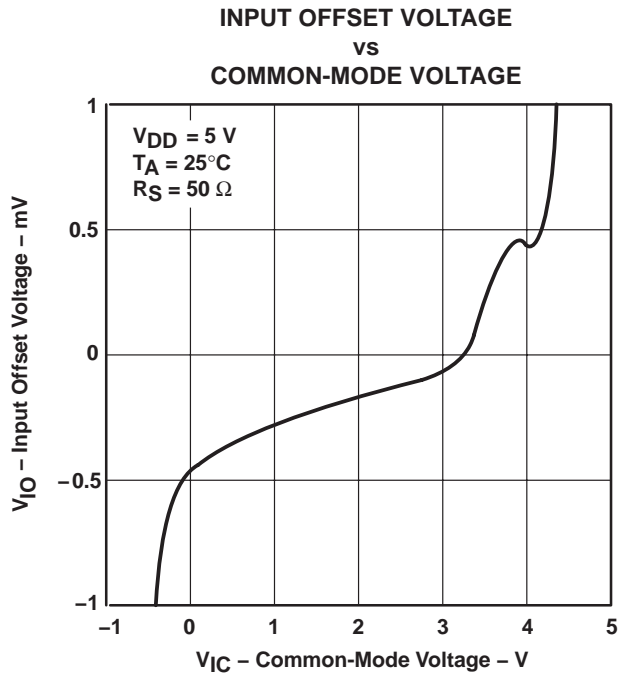

Figure 5

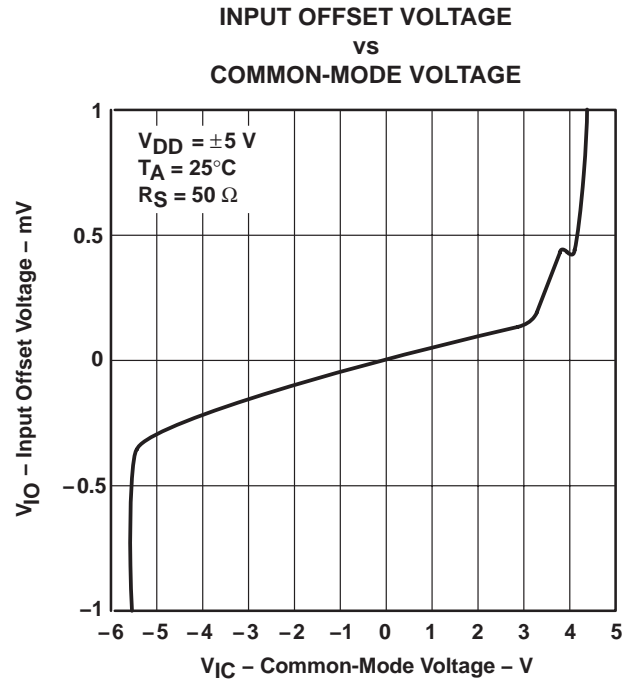

Figure 6

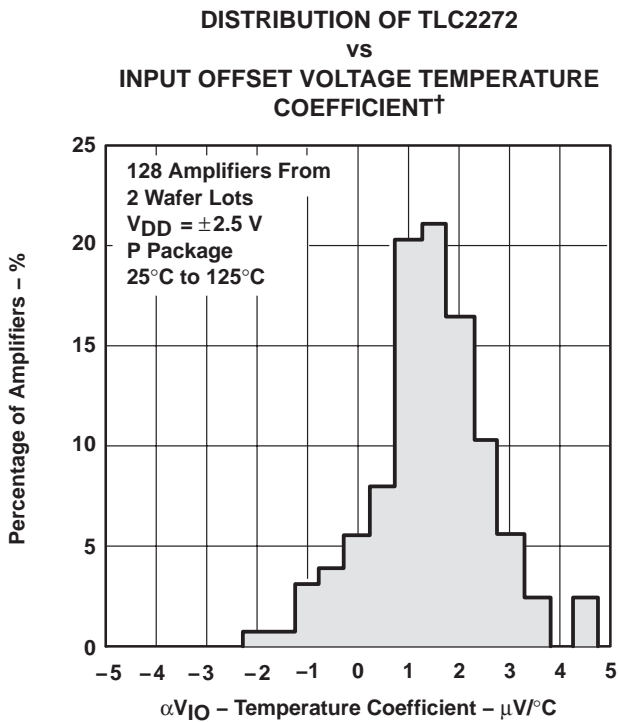

Figure 7

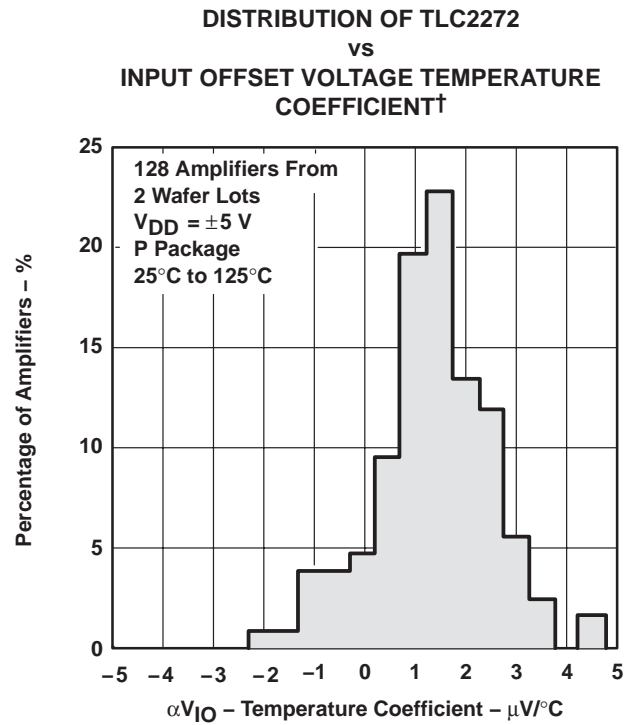

Figure 8

† Data at high and low temperatures are applicable only within the rated operating free-air temperature ranges of the various devices.

TYPICAL CHARACTERISTICS

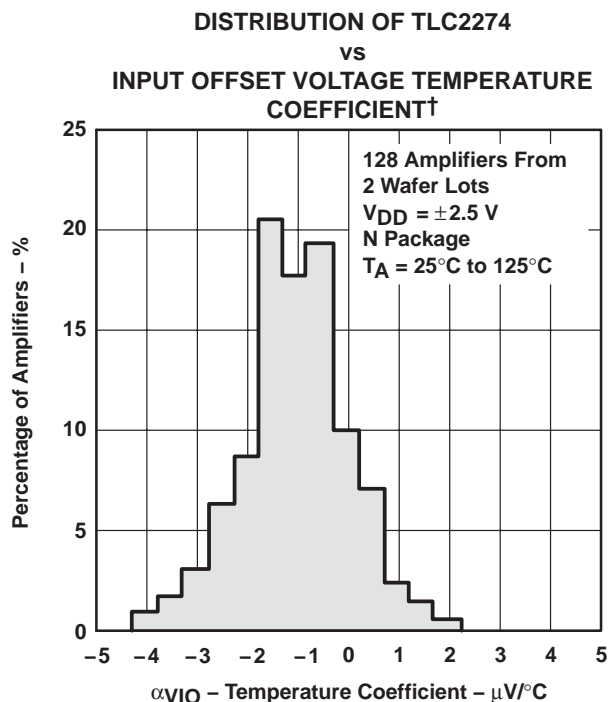

Figure 9

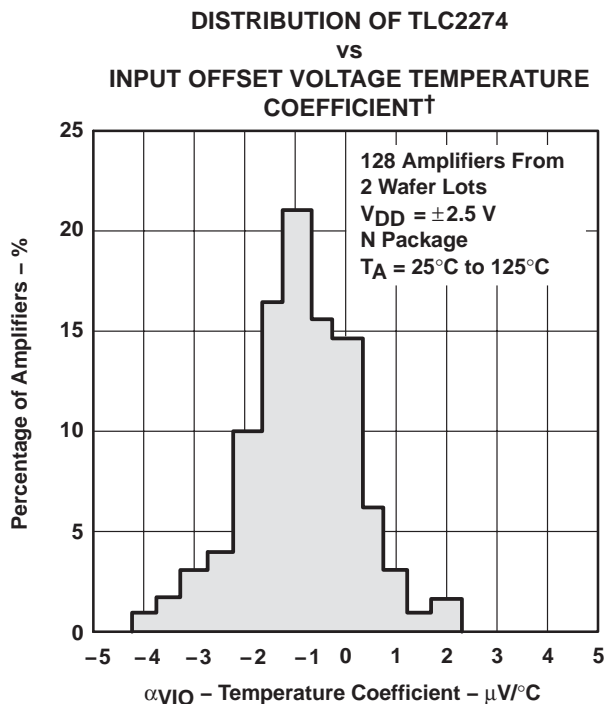

Figure 10

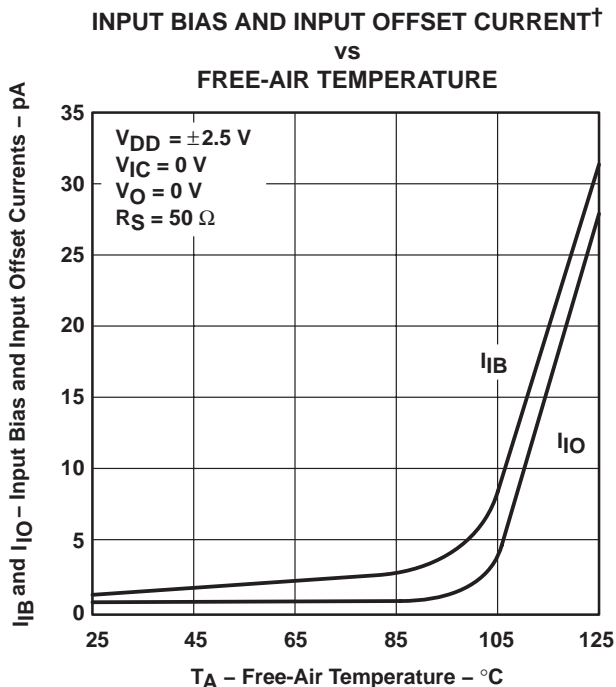

Figure 11

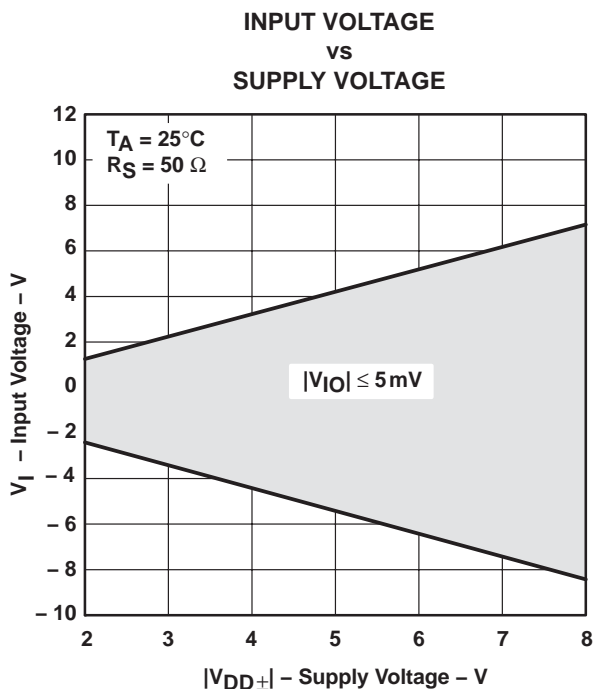

Figure 12

† Data at high and low temperatures are applicable only within the rated operating free-air temperature ranges of the various devices.

TYPICAL CHARACTERISTICS

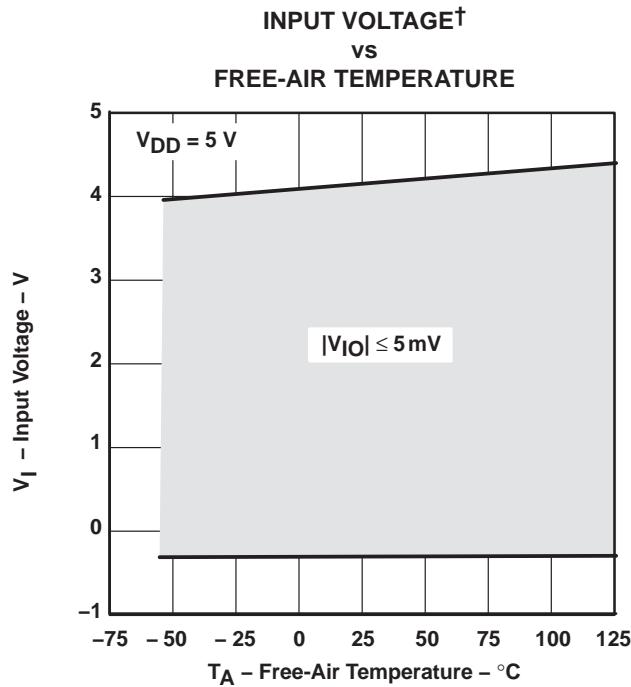

Figure 13

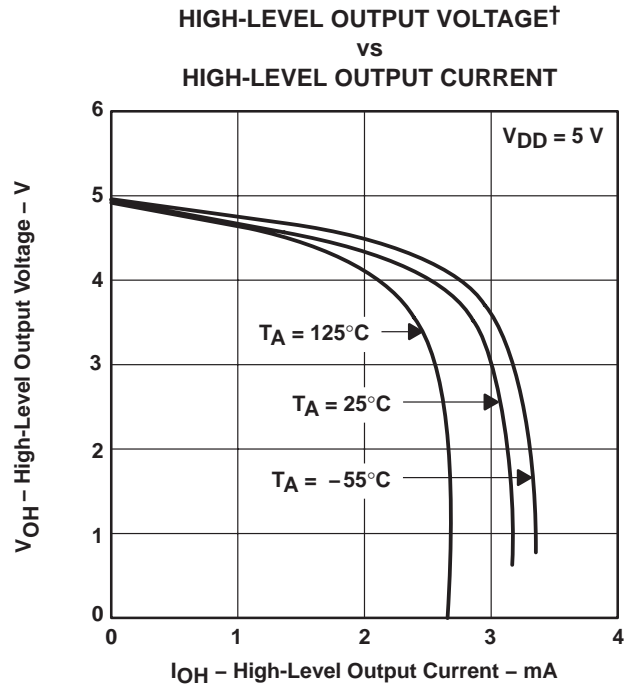

Figure 14

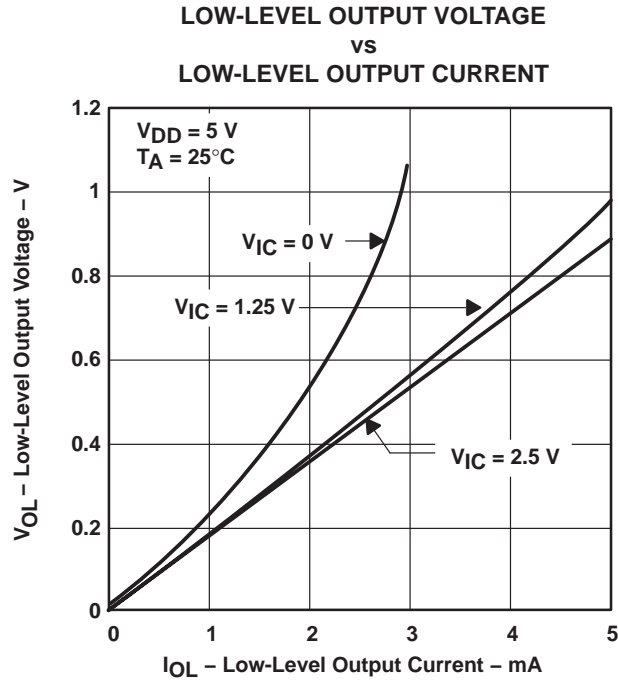

Figure 15

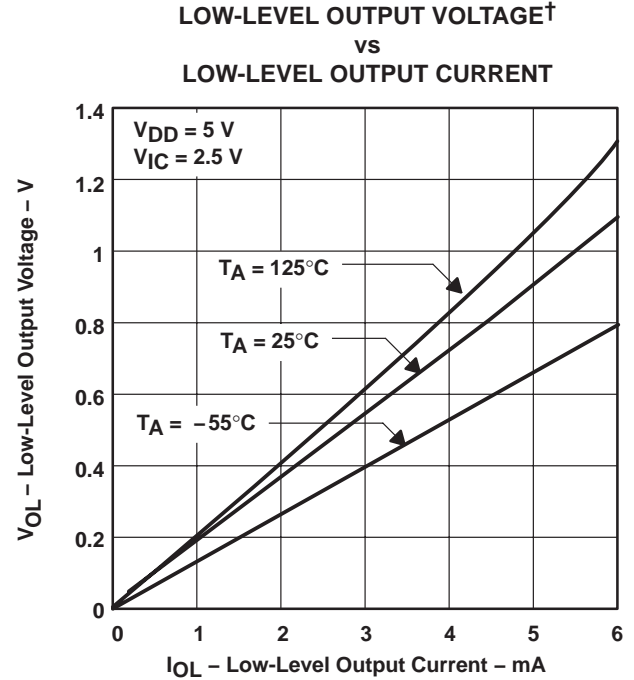

Figure 16

† Data at high and low temperatures are applicable only within the rated operating free-air temperature ranges of the various devices.

TYPICAL CHARACTERISTICS

MAXIMUM POSITIVE PEAK OUTPUT VOLTAGE†
vs
OUTPUT CURRENT

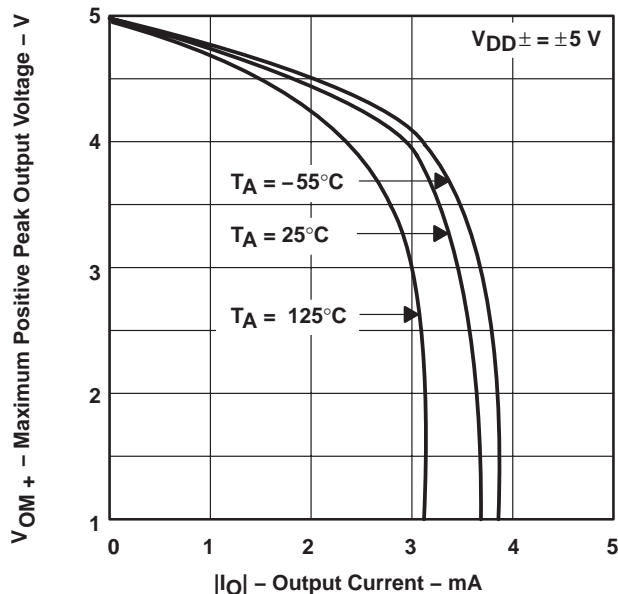

Figure 17

MAXIMUM NEGATIVE PEAK OUTPUT VOLTAGE†
vs
OUTPUT CURRENT

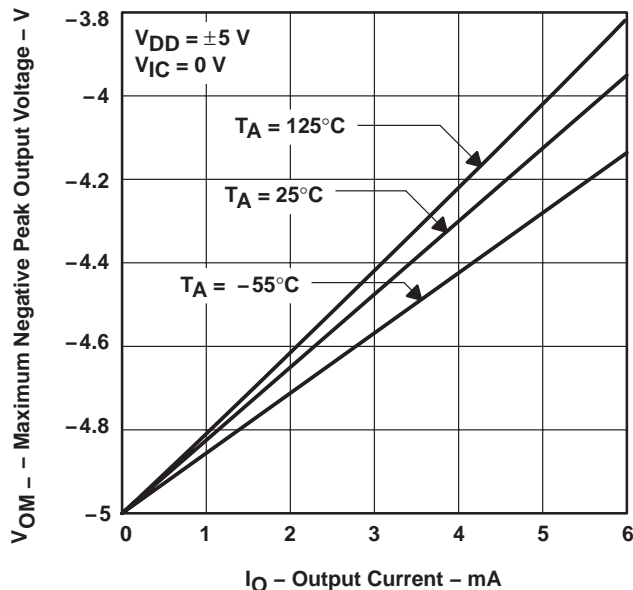

Figure 18

MAXIMUM PEAK-TO-PEAK OUTPUT VOLTAGE
vs
FREQUENCY

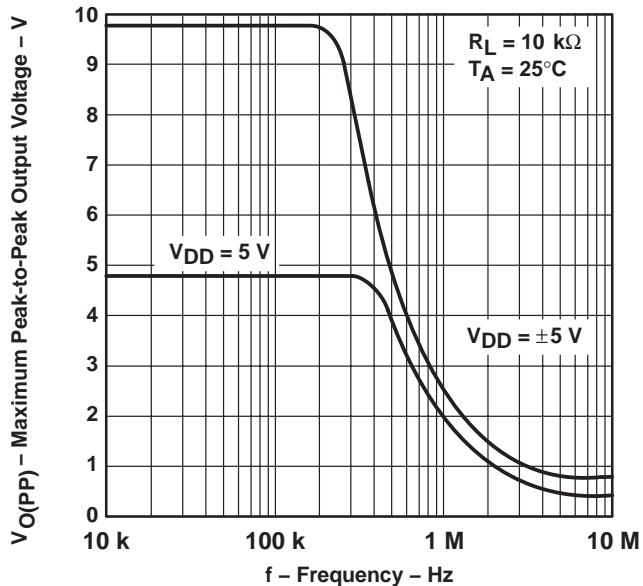

Figure 19

SHORT-CIRCUIT OUTPUT CURRENT
vs
SUPPLY VOLTAGE

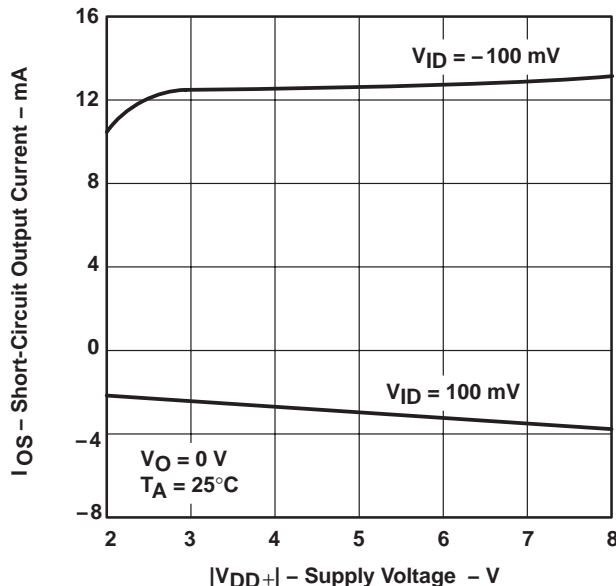

Figure 20

† Data at high and low temperatures are applicable only within the rated operating free-air temperature ranges of the various devices.

TYPICAL CHARACTERISTICS

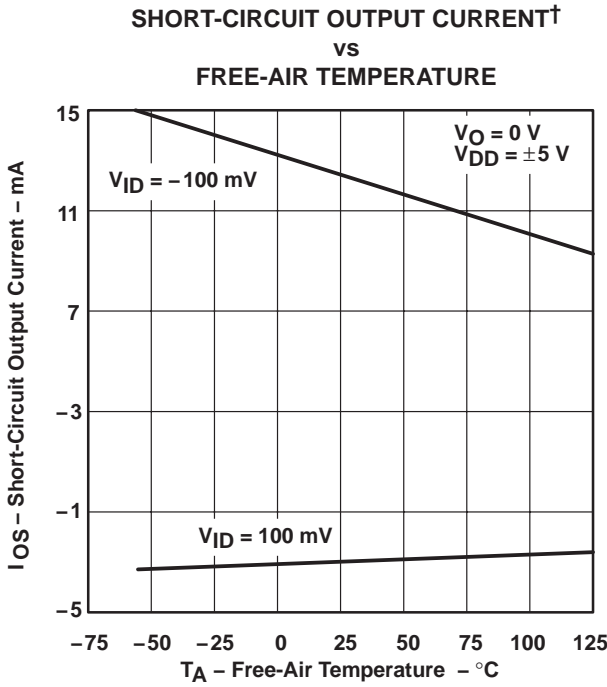

Figure 21

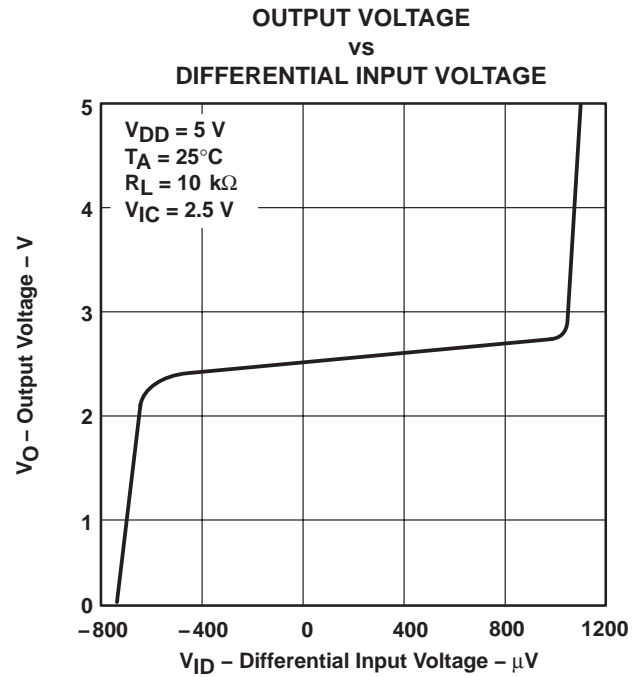

Figure 22

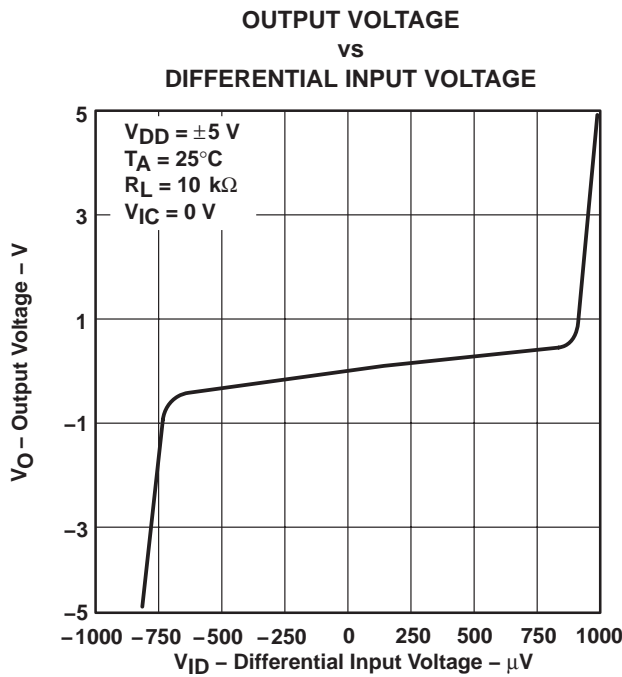

Figure 23

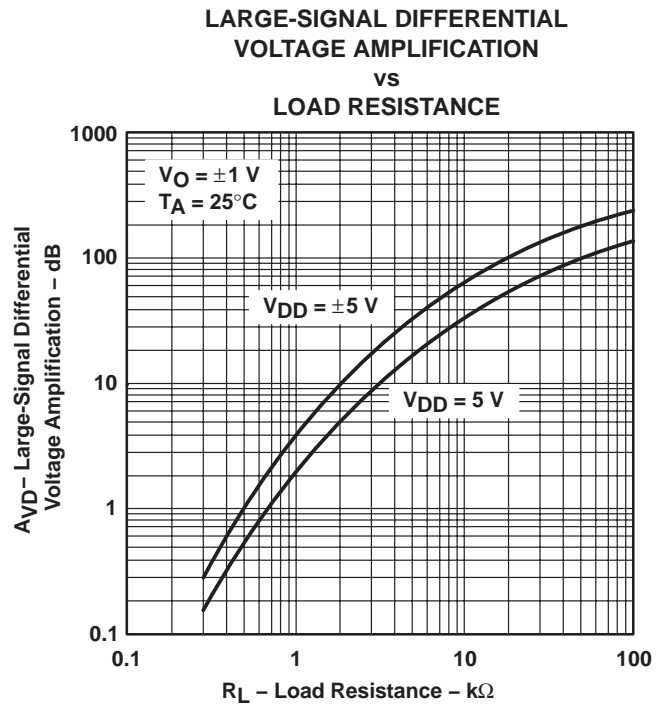

Figure 24

† Data at high and low temperatures are applicable only within the rated operating free-air temperature ranges of the various devices.

TYPICAL CHARACTERISTICS

LARGE-SIGNAL DIFFERENTIAL VOLTAGE AMPLIFICATION AND PHASE MARGIN

vs
FREQUENCY

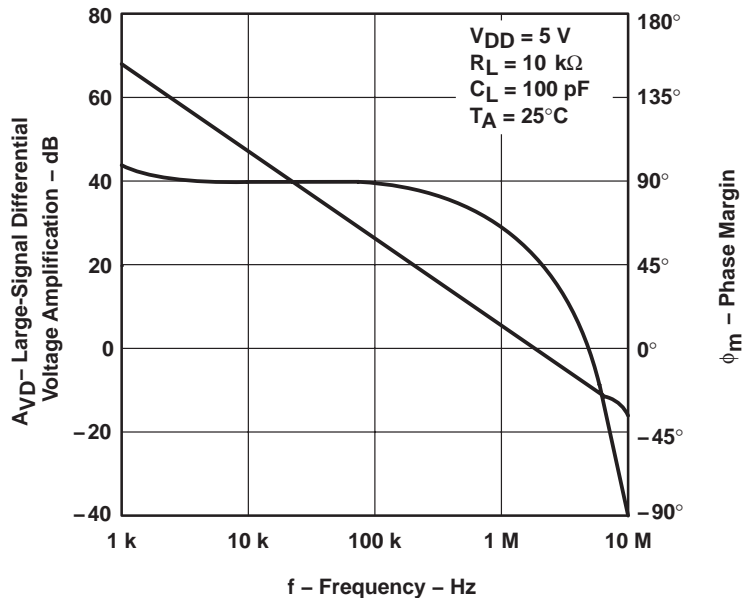

Figure 25

LARGE-SIGNAL DIFFERENTIAL VOLTAGE AMPLIFICATION AND PHASE MARGIN

vs
FREQUENCY

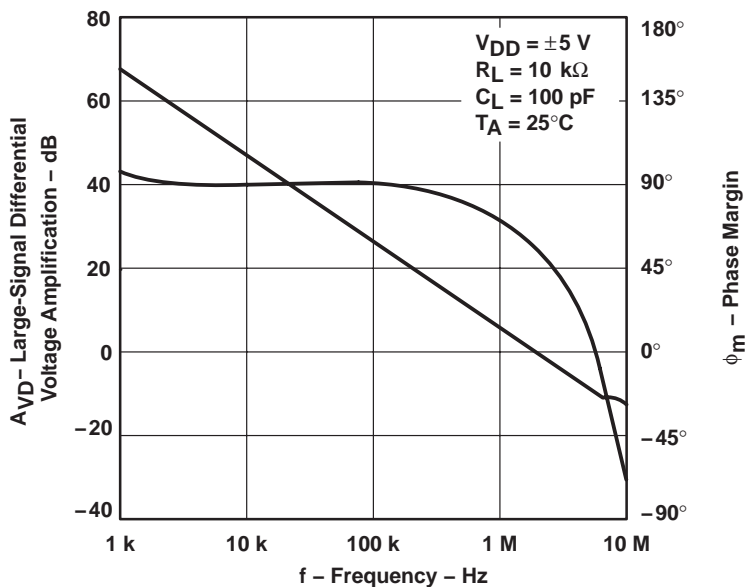

Figure 26

TYPICAL CHARACTERISTICS

LARGE-SIGNAL DIFFERENTIAL
 VOLTAGE AMPLIFICATION†
 vs
 FREE-AIR TEMPERATURE

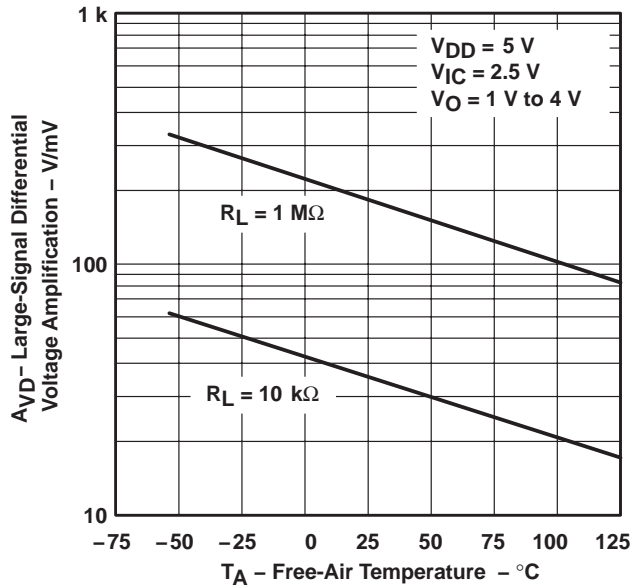

Figure 27

LARGE-SIGNAL DIFFERENTIAL
 VOLTAGE AMPLIFICATION†
 vs
 FREE-AIR TEMPERATURE

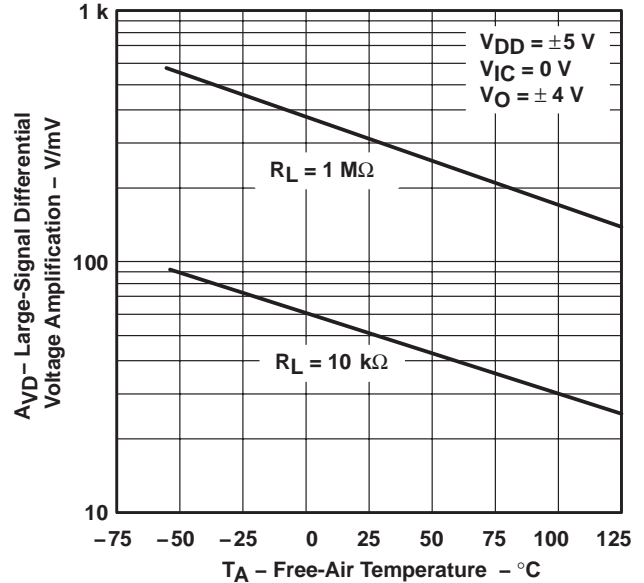

Figure 28

OUTPUT IMPEDANCE
 vs
 FREQUENCY

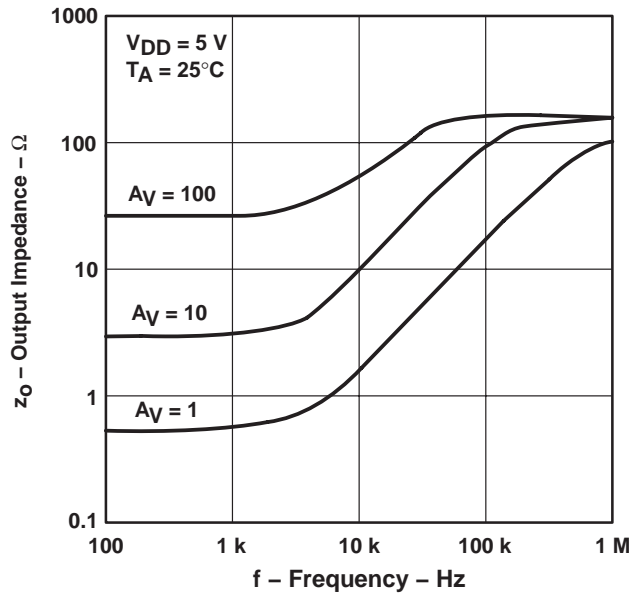

Figure 29

OUTPUT IMPEDANCE
 vs
 FREQUENCY

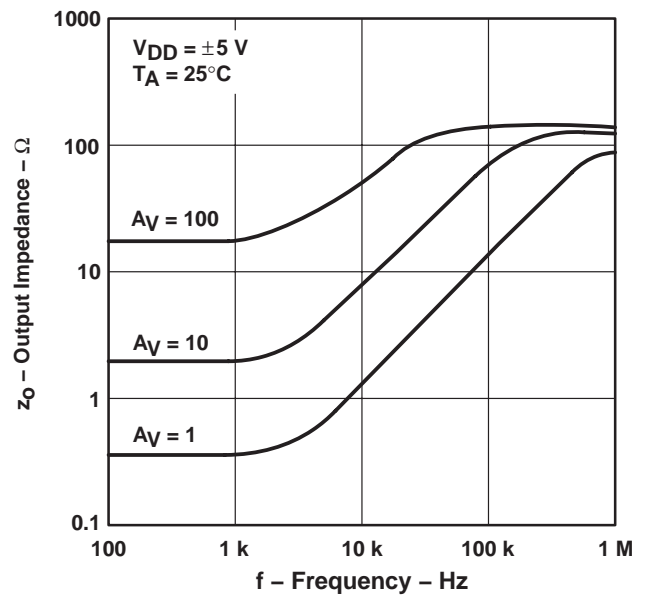

Figure 30

† Data at high and low temperatures are applicable only within the rated operating free-air temperature ranges of the various devices.

TYPICAL CHARACTERISTICS

**COMMON-MODE REJECTION RATIO
vs
FREQUENCY**

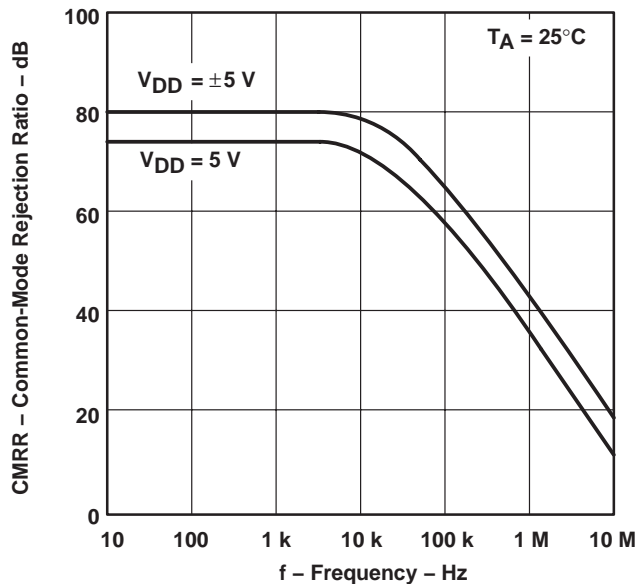

Figure 31

**COMMON-MODE REJECTION RATIO
vs
FREE-AIR TEMPERATURE**

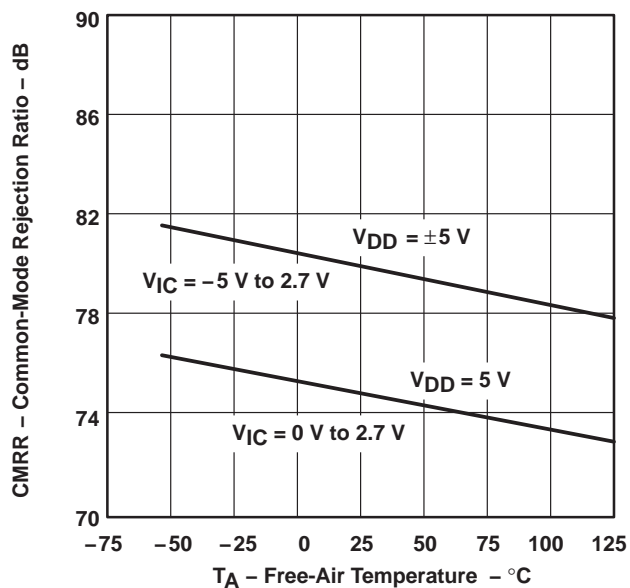

Figure 32

**SUPPLY-VOLTAGE REJECTION RATIO
vs
FREQUENCY**

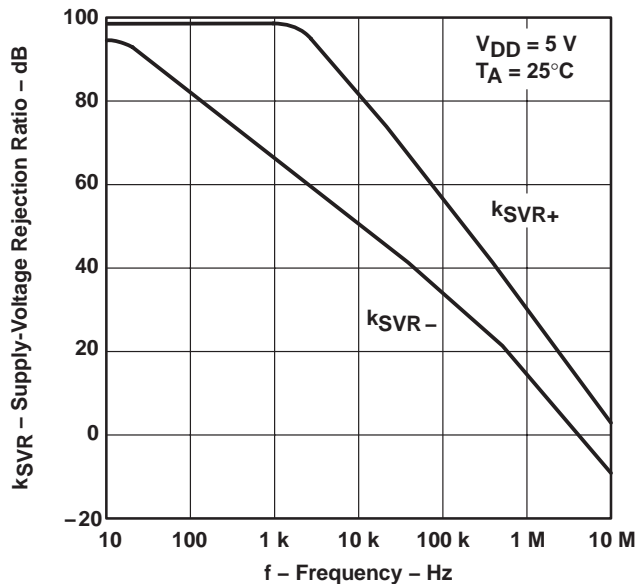

Figure 33

**SUPPLY-VOLTAGE REJECTION RATIO
vs
FREQUENCY**

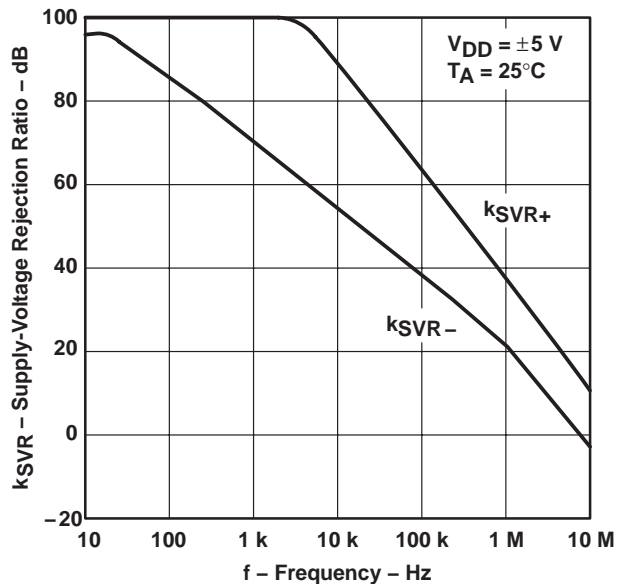
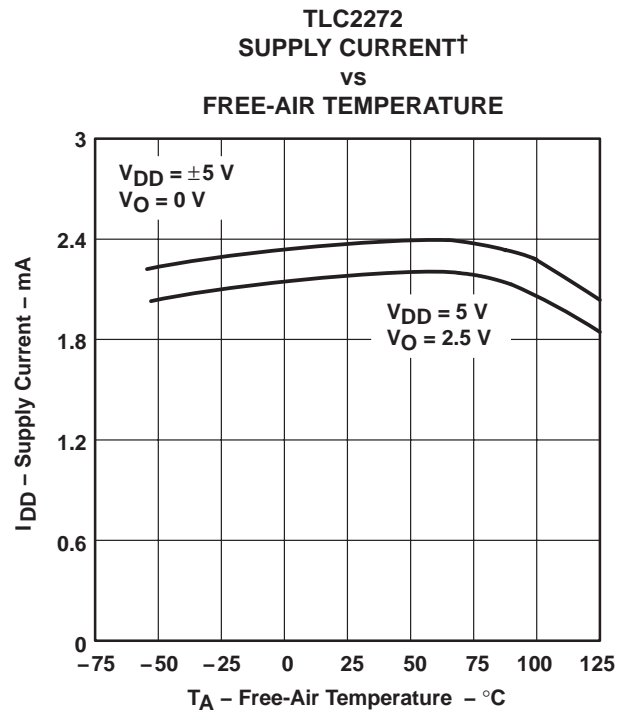
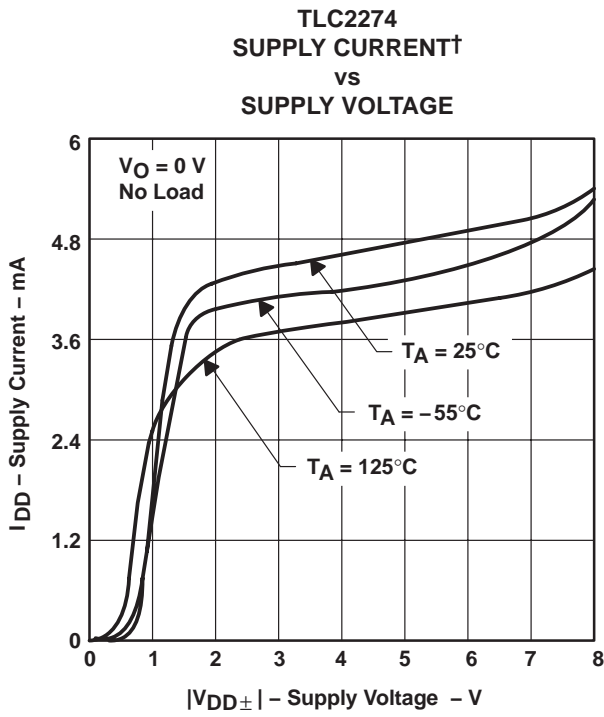
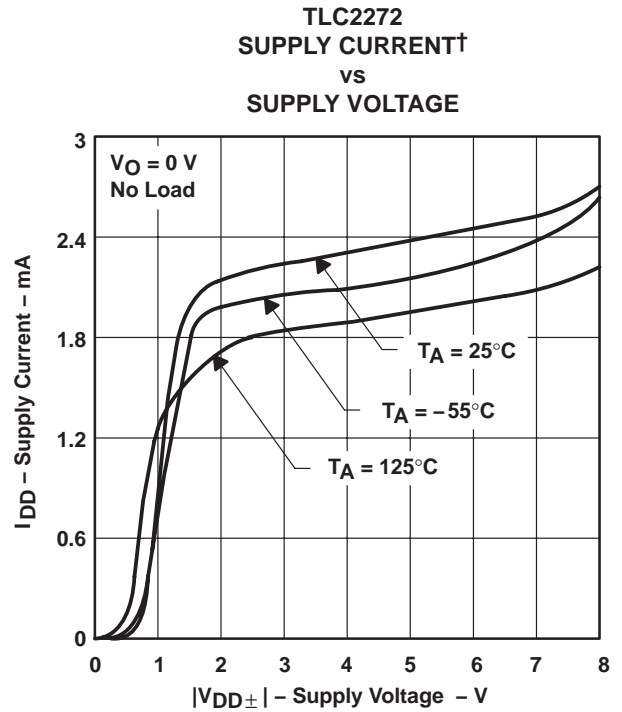
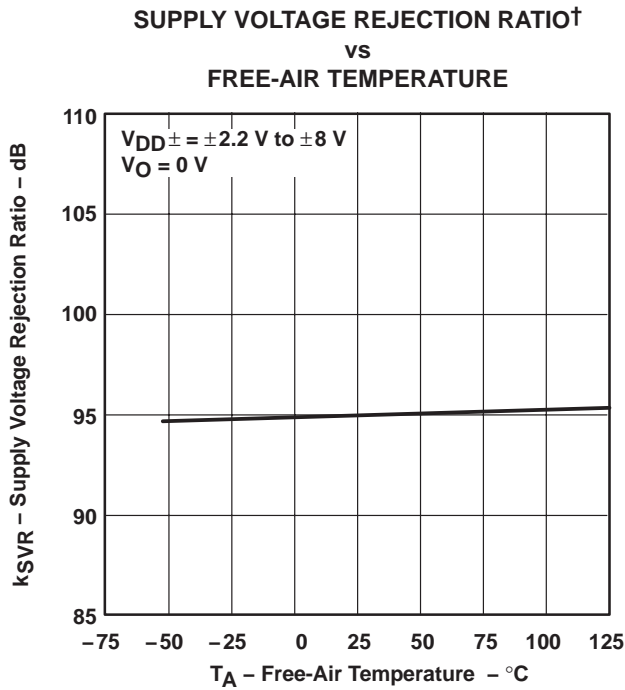

Figure 34

TYPICAL CHARACTERISTICS



† Data at high and low temperatures are applicable only within the rated operating free-air temperature ranges of the various devices.

TYPICAL CHARACTERISTICS

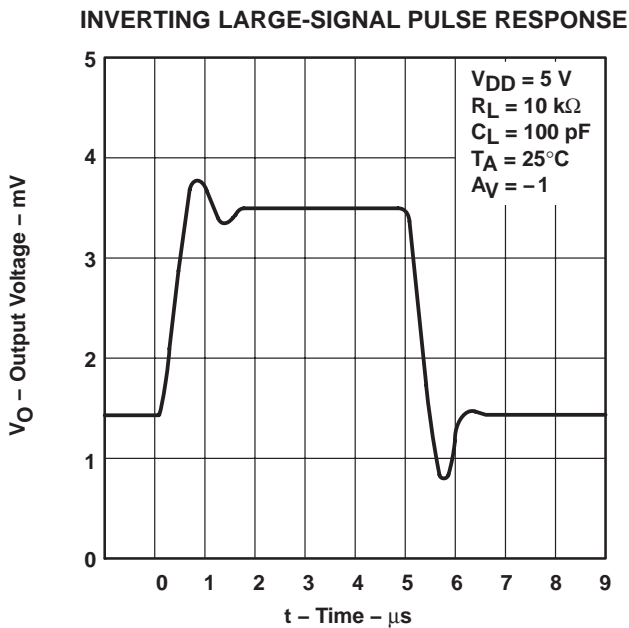
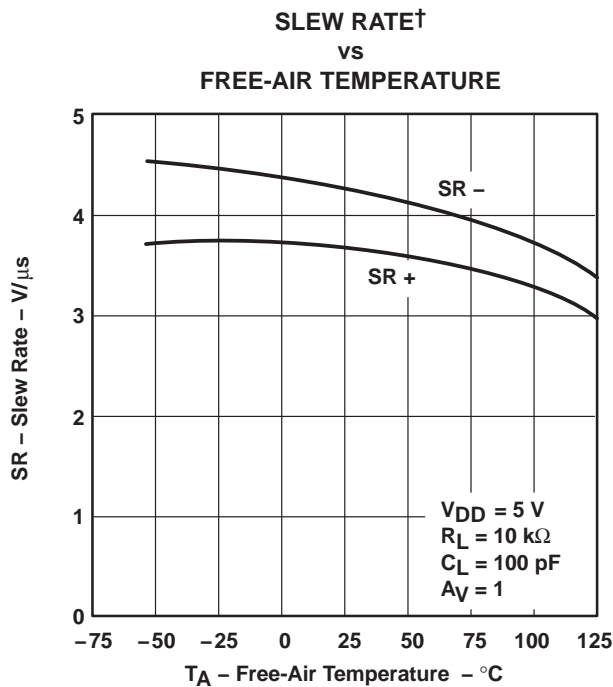
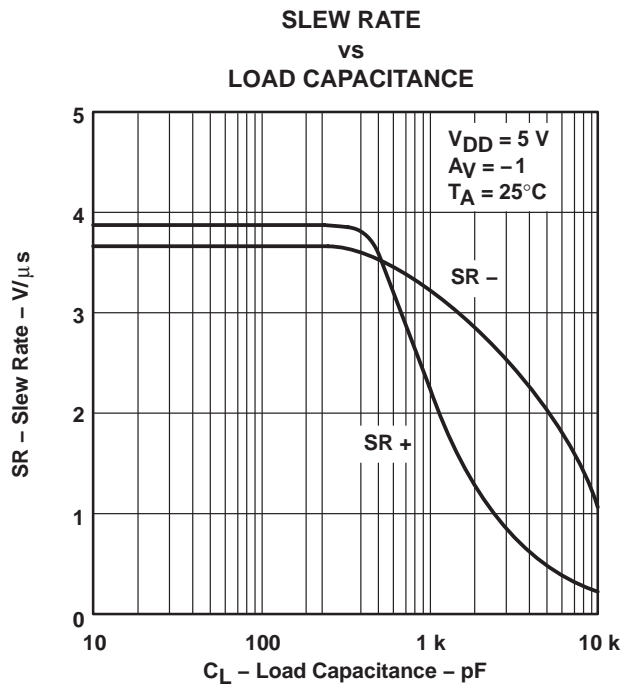
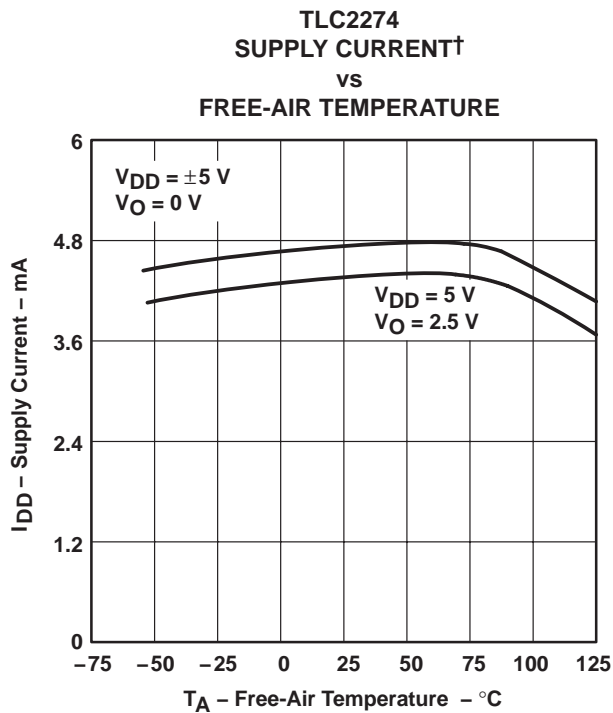

† Data at high and low temperatures are applicable only within the rated operating free-air temperature ranges of the various devices.

TYPICAL CHARACTERISTICS

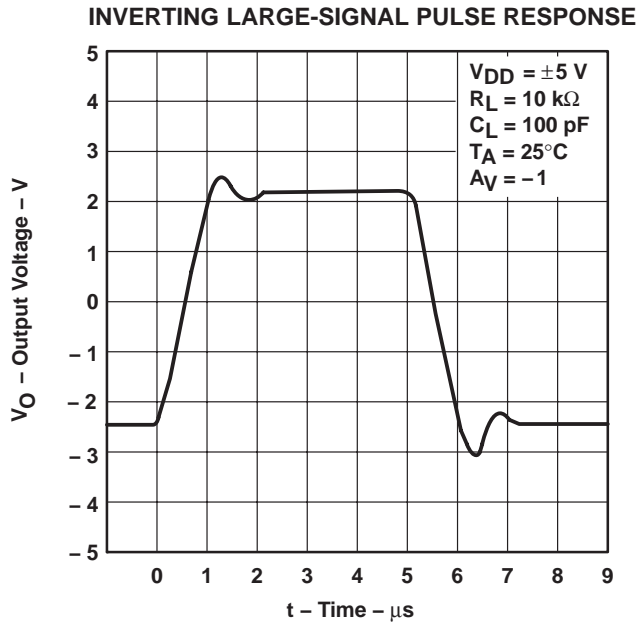

Figure 43

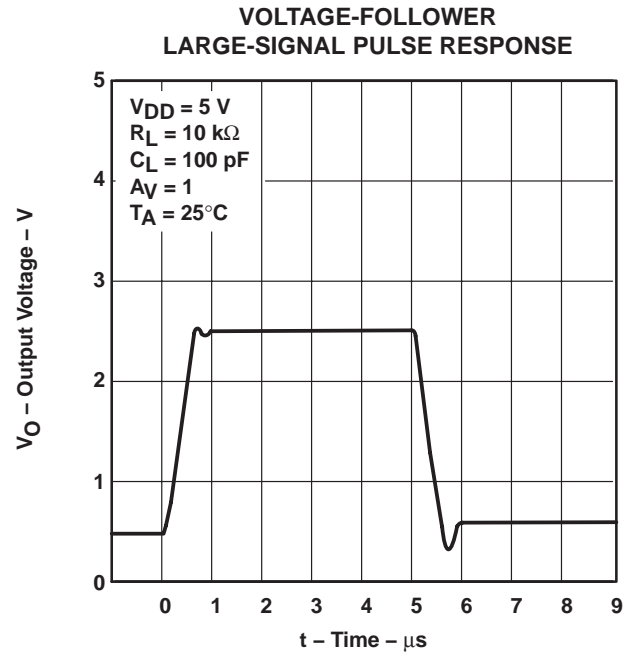

Figure 44

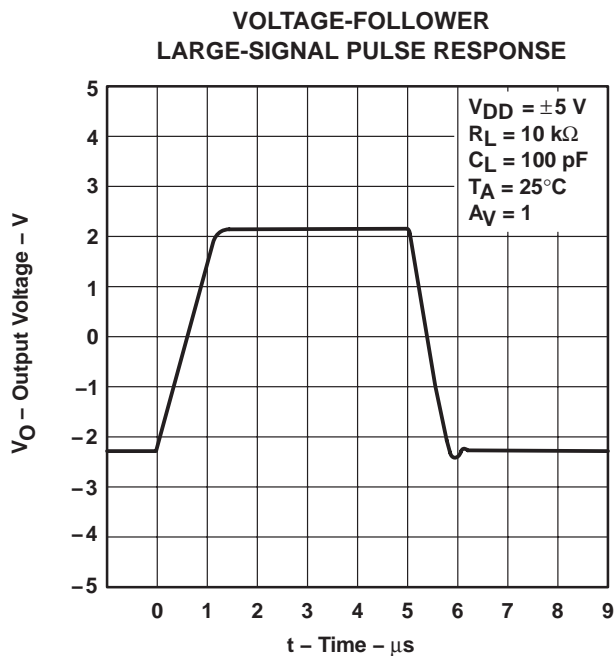

Figure 45

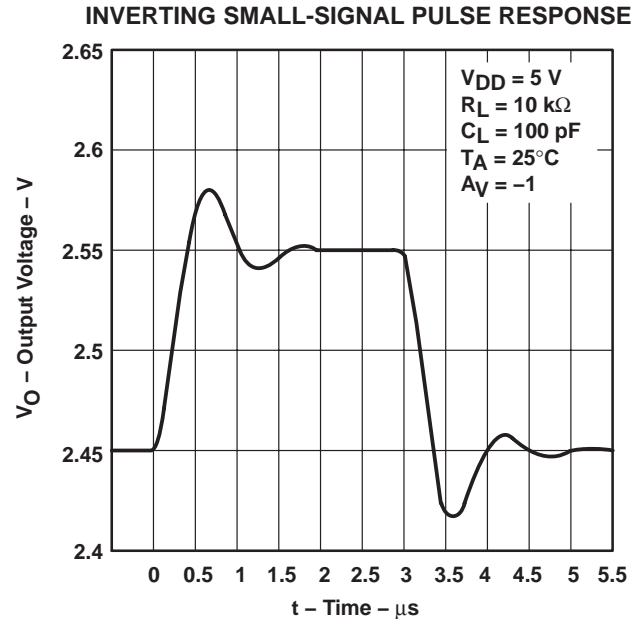

Figure 46

TYPICAL CHARACTERISTICS

INVERTING SMALL-SIGNAL PULSE RESPONSE

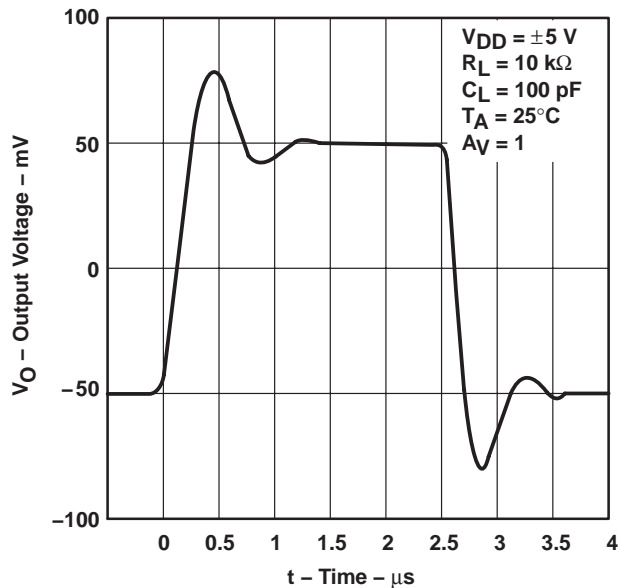

Figure 47

VOLTAGE-FOLLOWER SMALL-SIGNAL PULSE RESPONSE

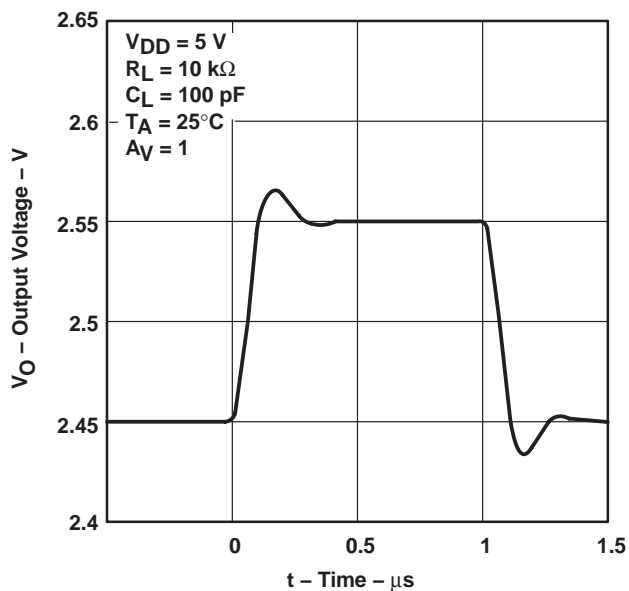

Figure 48

VOLTAGE-FOLLOWER SMALL-SIGNAL PULSE RESPONSE

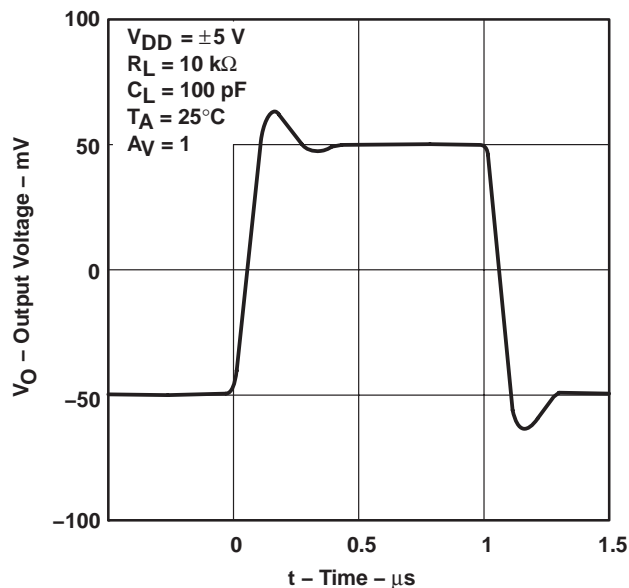

Figure 49

EQUIVALENT INPUT NOISE VOLTAGE vs FREQUENCY

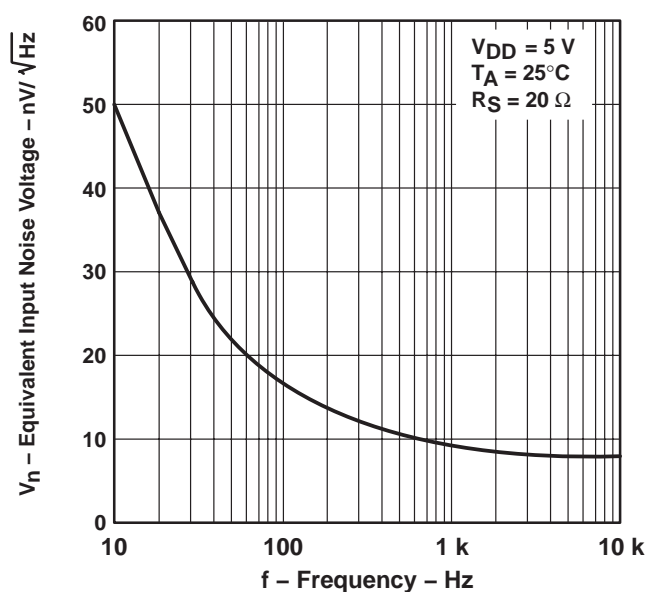

Figure 50

TYPICAL CHARACTERISTICS

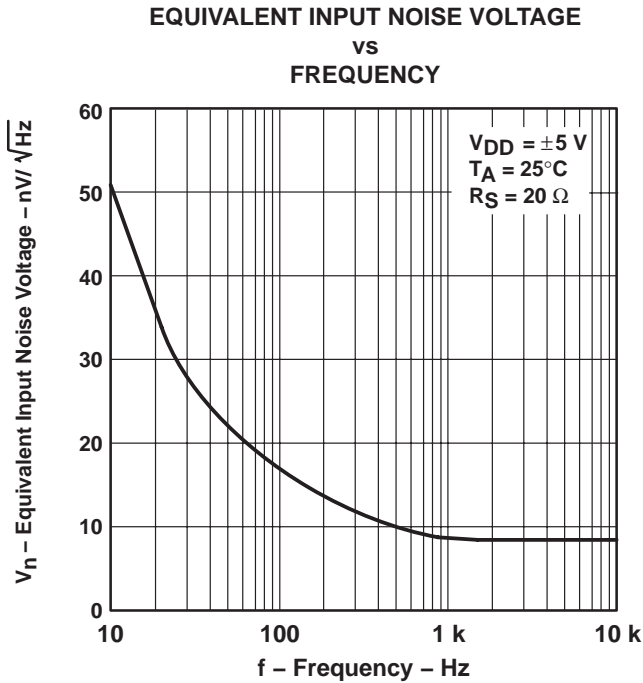

Figure 51

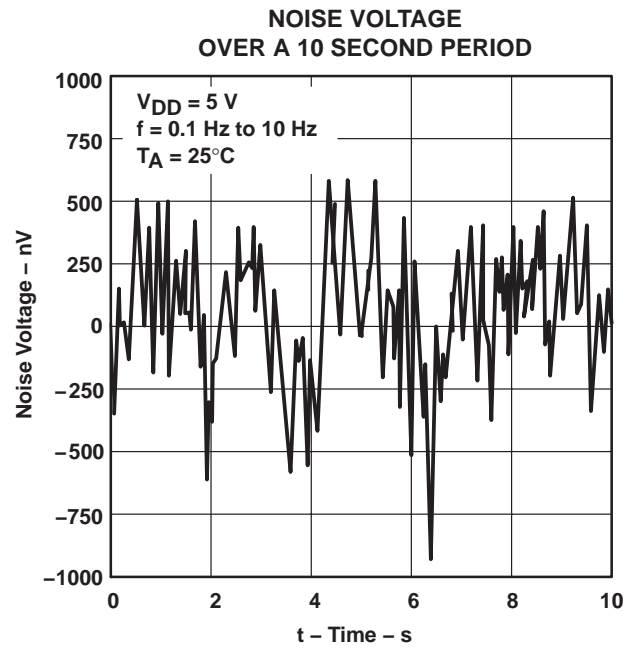

Figure 52

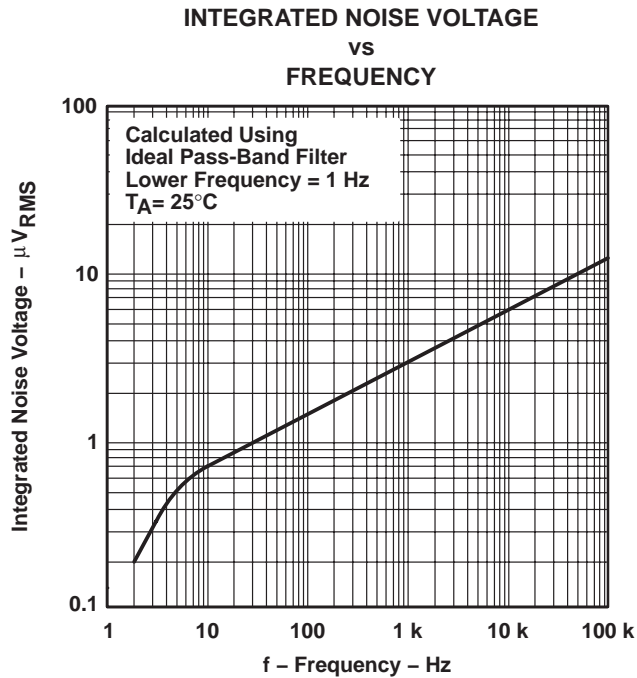

Figure 53

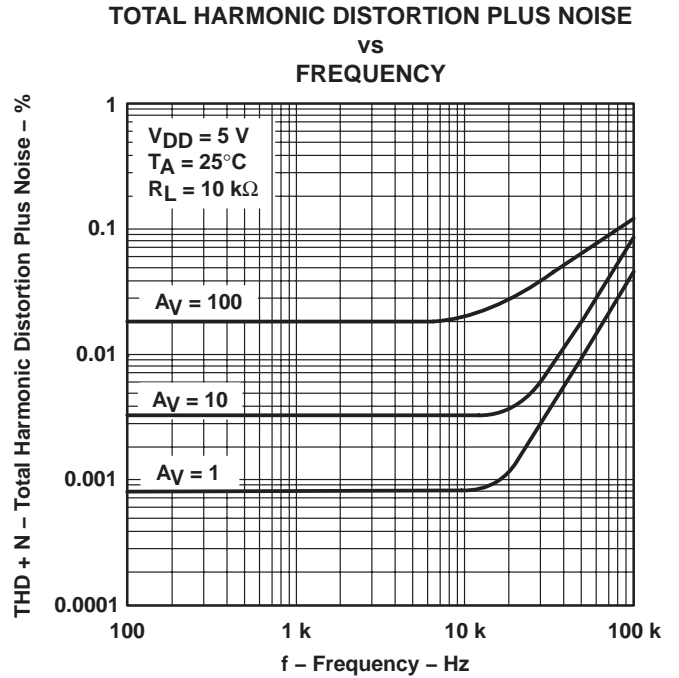

Figure 54

TYPICAL CHARACTERISTICS

GAIN-BANDWIDTH PRODUCT
vs
SUPPLY VOLTAGE

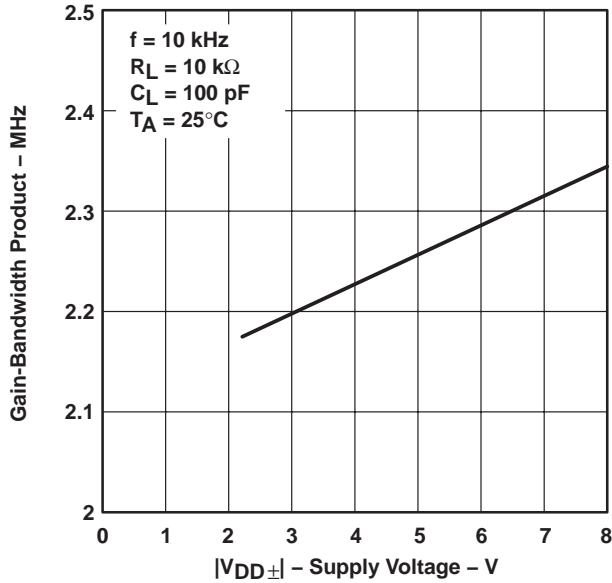

Figure 55

GAIN-BANDWIDTH PRODUCT†
vs
FREE-AIR TEMPERATURE

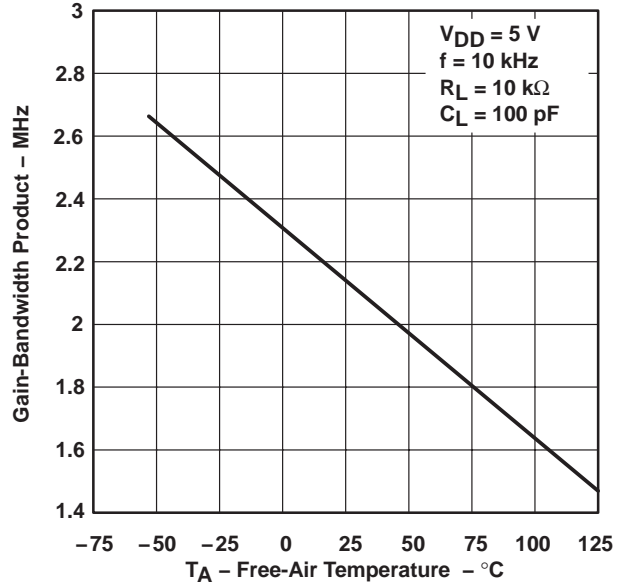

Figure 56

PHASE MARGIN
vs
LOAD CAPACITANCE

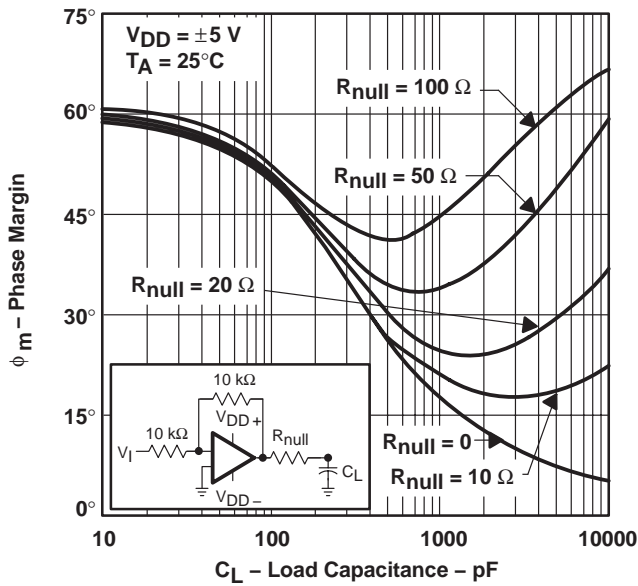

Figure 57

GAIN MARGIN
vs
LOAD CAPACITANCE

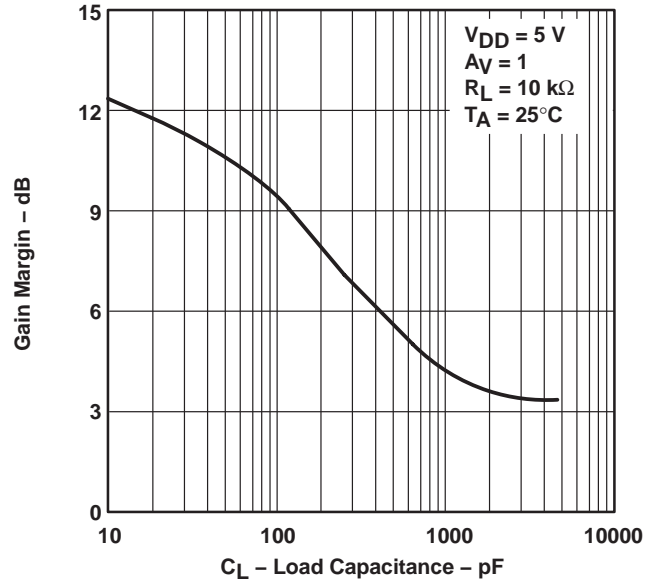

Figure 58

† Data at high and low temperatures are applicable only within the rated operating free-air temperature ranges of the various devices.

APPLICATION INFORMATION

macromodel information

Macromodel information provided was derived using Microsim *Parts™*, the model generation software used with Microsim *PSpice™*. The Boyle macromodel (see Note 5) and subcircuit in Figure 59 were generated using the TLC227x typical electrical and operating characteristics at $T_A = 25^\circ\text{C}$. Using this information, output simulations of the following key parameters can be generated to a tolerance of 20% (in most cases):

- Maximum positive output voltage swing
- Maximum negative output voltage swing
- Slew rate
- Quiescent power dissipation
- Input bias current
- Open-loop voltage amplification
- Unity gain frequency
- Common-mode rejection ratio
- Phase margin
- DC output resistance
- AC output resistance
- Short-circuit output current limit

NOTE 5: G. R. Boyle, B. M. Cohn, D. O. Pederson, and J. E. Solomon, "Macromodeling of Integrated Circuit Operational Amplifiers", *IEEE Journal of Solid-State Circuits*, SC-9, 353 (1974).

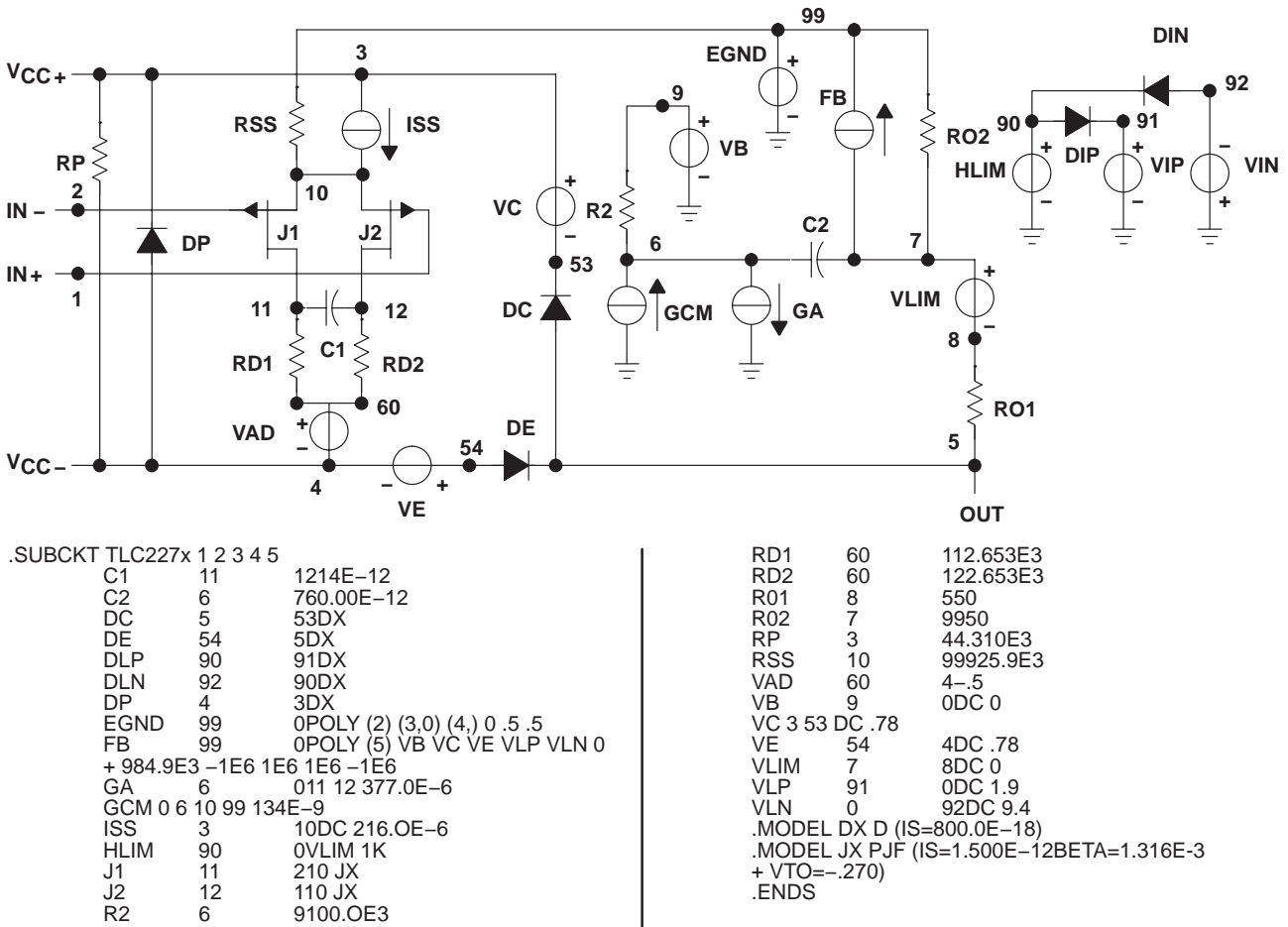

Figure 59. Boyle Macromodel and Subcircuit

PSpice and *Parts* are trademarks of MicroSim Corporation.

Macromodels, simulation models, or other models provided by TI, directly or indirectly, are not warranted by TI as fully representing all of the specification and operating characteristics of the semiconductor product to which the model relates.



PACKAGING INFORMATION

Orderable Device	Status ⁽¹⁾	Package Type	Package Drawing	Pins	Package Qty	Eco Plan ⁽²⁾	Lead/Ball Finish	MSL Peak Temp ⁽³⁾
TLC2272AQDRQ1	ACTIVE	SOIC	D	8	2500	Pb-Free (RoHS)	CU NIPDAU	Level-2-250C-1 YEAR/ Level-1-235C-UNLIM
TLC2272AQPWRQ1	ACTIVE	TSSOP	PW	8	2000	TBD	CU NIPDAU	Level-1-250C-UNLIM
TLC2272QDRQ1	ACTIVE	SOIC	D	8	2500	TBD	CU NIPDAU	Level-1-220C-UNLIM
TLC2272QPWRQ1	ACTIVE	TSSOP	PW	8	2000	TBD	CU NIPDAU	Level-1-250C-UNLIM
TLC2274AQDRQ1	ACTIVE	SOIC	D	14	2500	Pb-Free (RoHS)	CU NIPDAU	Level-2-250C-1 YEAR/ Level-1-235C-UNLIM
TLC2274AQPWRQ1	ACTIVE	TSSOP	PW	14	2000	TBD	CU NIPDAU	Level-1-250C-UNLIM
TLC2274QDRQ1	ACTIVE	SOIC	D	14	2500	Pb-Free (RoHS)	CU NIPDAU	Level-2-250C-1 YEAR/ Level-1-235C-UNLIM
TLC2274QPWRQ1	ACTIVE	TSSOP	PW	14	2000	TBD	CU NIPDAU	Level-1-250C-UNLIM

⁽¹⁾ The marketing status values are defined as follows:

ACTIVE: Product device recommended for new designs.

LIFEBUY: TI has announced that the device will be discontinued, and a lifetime-buy period is in effect.

NRND: Not recommended for new designs. Device is in production to support existing customers, but TI does not recommend using this part in a new design.

PREVIEW: Device has been announced but is not in production. Samples may or may not be available.

OBSOLETE: TI has discontinued the production of the device.

⁽²⁾ Eco Plan - The planned eco-friendly classification: Pb-Free (RoHS) or Green (RoHS & no Sb/Br) - please check <http://www.ti.com/productcontent> for the latest availability information and additional product content details.

TBD: The Pb-Free/Green conversion plan has not been defined.

Pb-Free (RoHS): TI's terms "Lead-Free" or "Pb-Free" mean semiconductor products that are compatible with the current RoHS requirements for all 6 substances, including the requirement that lead not exceed 0.1% by weight in homogeneous materials. Where designed to be soldered at high temperatures, TI Pb-Free products are suitable for use in specified lead-free processes.

Green (RoHS & no Sb/Br): TI defines "Green" to mean Pb-Free (RoHS compatible), and free of Bromine (Br) and Antimony (Sb) based flame retardants (Br or Sb do not exceed 0.1% by weight in homogeneous material)

⁽³⁾ MSL, Peak Temp. -- The Moisture Sensitivity Level rating according to the JEDEC industry standard classifications, and peak solder temperature.

Important Information and Disclaimer:The information provided on this page represents TI's knowledge and belief as of the date that it is provided. TI bases its knowledge and belief on information provided by third parties, and makes no representation or warranty as to the accuracy of such information. Efforts are underway to better integrate information from third parties. TI has taken and continues to take reasonable steps to provide representative and accurate information but may not have conducted destructive testing or chemical analysis on incoming materials and chemicals. TI and TI suppliers consider certain information to be proprietary, and thus CAS numbers and other limited information may not be available for release.

In no event shall TI's liability arising out of such information exceed the total purchase price of the TI part(s) at issue in this document sold by TI to Customer on an annual basis.

D (R-PDSO-G14)

PLASTIC SMALL-OUTLINE PACKAGE



- NOTES:
- A. All linear dimensions are in inches (millimeters).
 - B. This drawing is subject to change without notice.
 - C. Body dimensions do not include mold flash or protrusion not to exceed 0.006 (0,15).
 - D. Falls within JEDEC MS-012 variation AB.

D (R-PDSO-G8)

PLASTIC SMALL-OUTLINE PACKAGE



- NOTES:
- A. All linear dimensions are in inches (millimeters).
 - B. This drawing is subject to change without notice.
 - C. Body dimensions do not include mold flash or protrusion not to exceed 0.006 (0,15).
 - D. Falls within JEDEC MS-012 variation AA.

PW (R-PDSO-G**)

PLASTIC SMALL-OUTLINE PACKAGE

14 PINS SHOWN



4040064/F 01/97

- NOTES: A. All linear dimensions are in millimeters.
 B. This drawing is subject to change without notice.
 C. Body dimensions do not include mold flash or protrusion not to exceed 0,15.
 D. Falls within JEDEC MO-153

IMPORTANT NOTICE

Texas Instruments Incorporated and its subsidiaries (TI) reserve the right to make corrections, modifications, enhancements, improvements, and other changes to its products and services at any time and to discontinue any product or service without notice. Customers should obtain the latest relevant information before placing orders and should verify that such information is current and complete. All products are sold subject to TI's terms and conditions of sale supplied at the time of order acknowledgment.

TI warrants performance of its hardware products to the specifications applicable at the time of sale in accordance with TI's standard warranty. Testing and other quality control techniques are used to the extent TI deems necessary to support this warranty. Except where mandated by government requirements, testing of all parameters of each product is not necessarily performed.

TI assumes no liability for applications assistance or customer product design. Customers are responsible for their products and applications using TI components. To minimize the risks associated with customer products and applications, customers should provide adequate design and operating safeguards.

TI does not warrant or represent that any license, either express or implied, is granted under any TI patent right, copyright, mask work right, or other TI intellectual property right relating to any combination, machine, or process in which TI products or services are used. Information published by TI regarding third-party products or services does not constitute a license from TI to use such products or services or a warranty or endorsement thereof. Use of such information may require a license from a third party under the patents or other intellectual property of the third party, or a license from TI under the patents or other intellectual property of TI.

Reproduction of information in TI data books or data sheets is permissible only if reproduction is without alteration and is accompanied by all associated warranties, conditions, limitations, and notices. Reproduction of this information with alteration is an unfair and deceptive business practice. TI is not responsible or liable for such altered documentation.

Resale of TI products or services with statements different from or beyond the parameters stated by TI for that product or service voids all express and any implied warranties for the associated TI product or service and is an unfair and deceptive business practice. TI is not responsible or liable for any such statements.

Following are URLs where you can obtain information on other Texas Instruments products and application solutions:

Products		Applications	
Amplifiers	amplifier.ti.com	Audio	www.ti.com/audio
Data Converters	dataconverter.ti.com	Automotive	www.ti.com/automotive
DSP	dsp.ti.com	Broadband	www.ti.com/broadband
Interface	interface.ti.com	Digital Control	www.ti.com/digitalcontrol
Logic	logic.ti.com	Military	www.ti.com/military
Power Mgmt	power.ti.com	Optical Networking	www.ti.com/opticalnetwork
Microcontrollers	microcontroller.ti.com	Security	www.ti.com/security
		Telephony	www.ti.com/telephony
		Video & Imaging	www.ti.com/video
		Wireless	www.ti.com/wireless

Mailing Address: Texas Instruments
Post Office Box 655303 Dallas, Texas 75265