

# Small, chip LEDs

## SML-310 Series

The SLM-310 series are small, chip LEDs. The compact and leadless design of these LEDs allows for high mounting density.

### ●Features

- 1) Four colors: red, orange, yellow and green.
- 2) Rectangular and leadless (1.6 x 0.8 mm, 0.8 mm thick)
- 3) Can be mounted by automatic mounting.

### ●External dimensions (Units : mm)

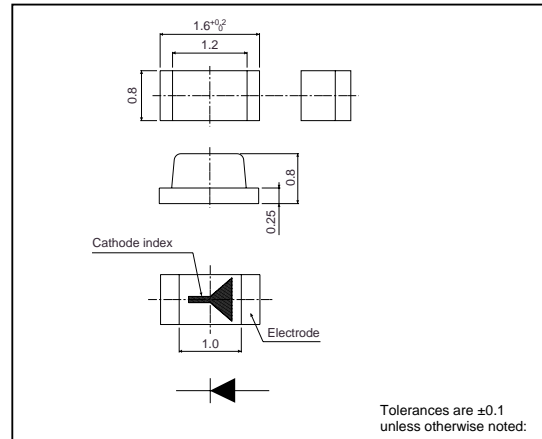

### ●Selection guide

Emitting color Lens	Red	Orange	Yellow	Green
	Transparent clear	SML-310JT	SML-310DT	SML-310YT
	SML-310LT	-	-	SML-310PT
	SML-310VT	-	-	SML-310FT

### ●Absolute maximum ratings (Ta=25°C)

Parameter	Symbol	Limits		Unit
		Bright red (L, J)	Other colors	
Power dissipation	P <sub>D</sub>	60	55	mW
Forward current	I <sub>F</sub>	25	20	mA
Peak forward current	I <sub>FP</sub>	75	60	mA*
Reverse voltage	V <sub>R</sub>	4		V
Operating temperature	T <sub>opr</sub>	-30~+85		°C
Storage temperature	T <sub>stg</sub>	-40~+85		°C

\* Pulse width 1ms Duty 1 / 5

## LED lamps

### ●Electrical and optical characteristics (Ta=25°C)

Parameter	Color	Forward voltage			Reverse current			Luminous intensity			Peak wavelength		Spectral line half width	
		V <sub>F</sub> (V)		Cond.	I <sub>R</sub> (μA)	Cond.	I <sub>V</sub> (mcd)		λ <sub>P</sub> (nm)	Cond.	Δλ(nm)	Cond.		
		Typ.	Max.	I <sub>F</sub> (mA)	Max.	V <sub>R</sub> (V)	Min.	Typ.	I <sub>F</sub> (mA)	Typ.	I <sub>F</sub> (mA)	Typ.	I <sub>F</sub> (mA)	
SML-310	JT	Red	1.9	2.5	20	100	4	14.0	40.0	20	660	20	25	20
	LT	Red	1.75	2.5	20	100	4	3.6	10.0	20	660	20	25	20
	VT	Red	2.0	2.8	20	100	4	1.4	4.0	20	650	20	40	20
	DT	Orange	2.0	2.8	20	100	4	2.2	6.3	20	610	20	40	20
	YT	Yellow	2.1	2.8	20	100	4	2.2	6.3	20	585	20	40	20
	MT	Green	2.2	2.8	20	100	4	3.6	16.0	20	570	20	40	20
	FT	Green	2.2	2.8	20	100	4	1.4	4.0	20	560	20	40	20
	PT	Green	2.2	2.8	20	100	4	1.4	4.0	20	555	20	40	20

### ●Directional pattern

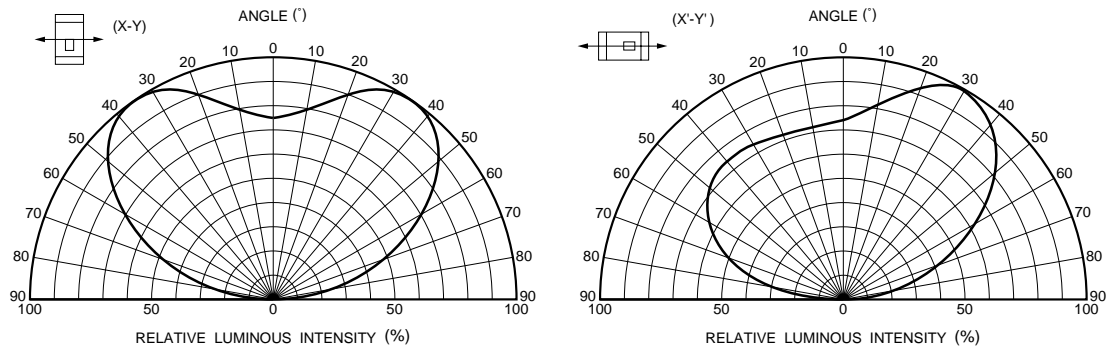

Fig. 1 Directional pattern

### ●Electrical characteristics curves 1 (SML-310LT, SML-310JT) (Bright red)

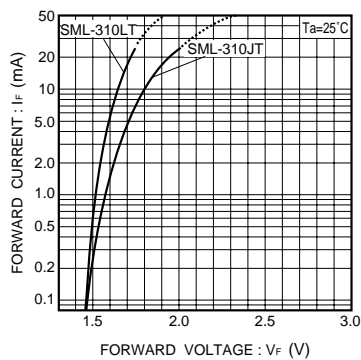

Fig. 2 Forward current vs. forward voltage

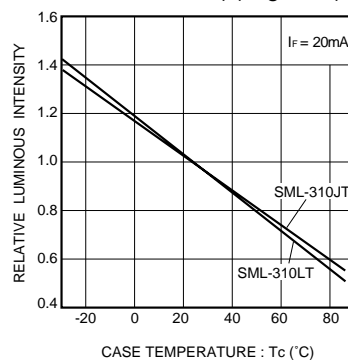

Fig. 3 Luminous intensity vs. case temperature

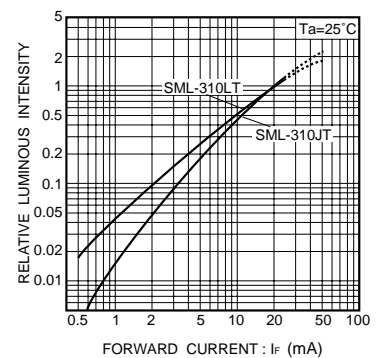

Fig. 4 Luminous intensity vs. forward current

LED lamps

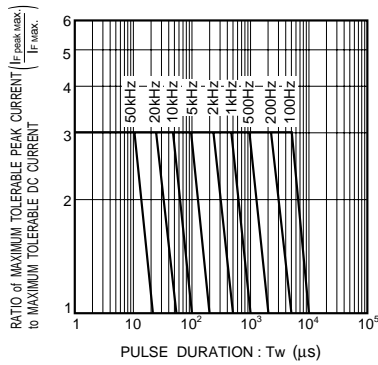

Fig. 5 Maximum tolerable peak current vs. pulse duration

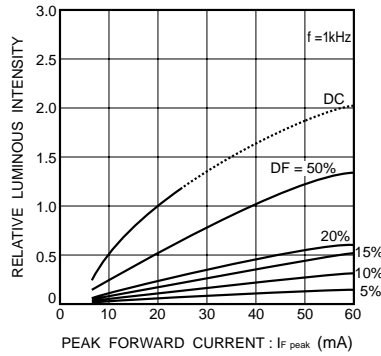

Fig. 6 Luminous intensity vs. peak forward current

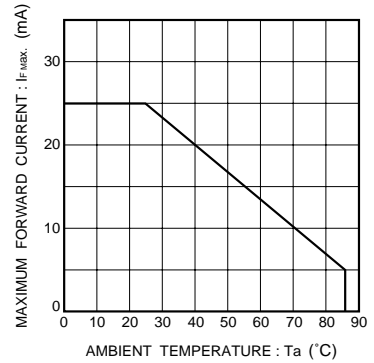

Fig. 7 Maximum forward current vs. ambient temperature

●Electrical characteristics curves 2 (SML-310VT) (red)

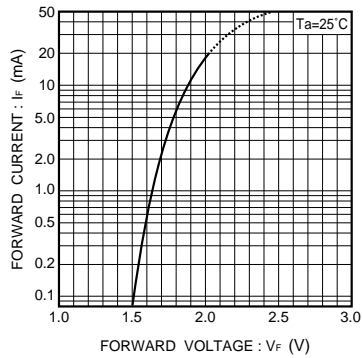

Fig. 8 Forward current vs. forward voltage

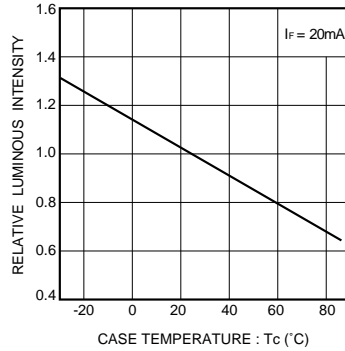

Fig. 9 Luminous intensity vs. case temperature

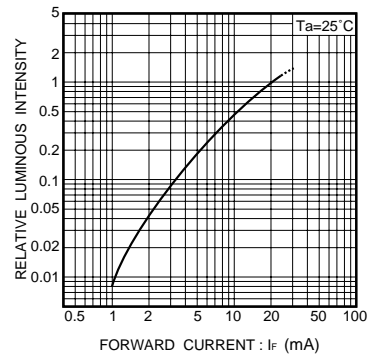

Fig. 10 Luminous intensity vs. forward current

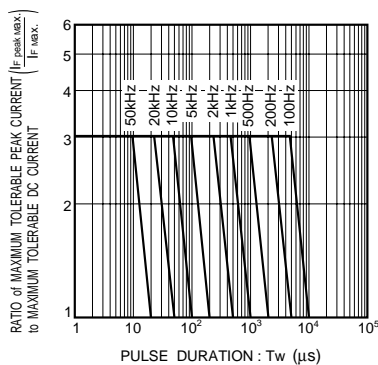

Fig. 11 Maximum tolerable peak current vs. pulse duration

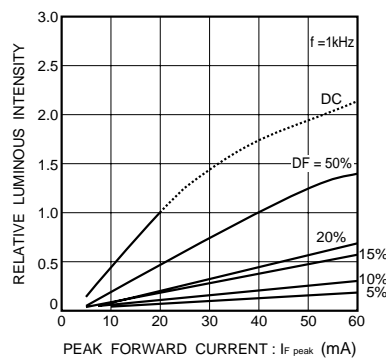

Fig. 12 Luminous intensity vs. peak forward current

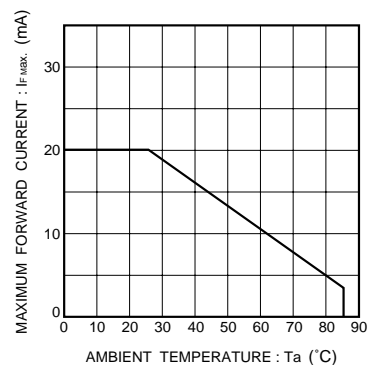

Fig. 13 Maximum forward current vs. ambient temperature

LED lamps

●Electrical characteristics curves 3 (SML-310DT) (orange)

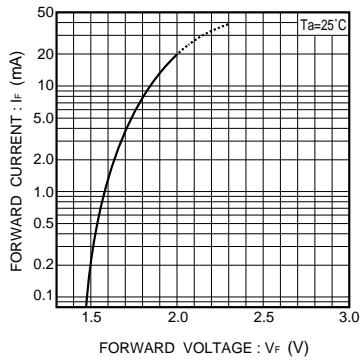

Fig. 14 Forward current vs. forward voltage

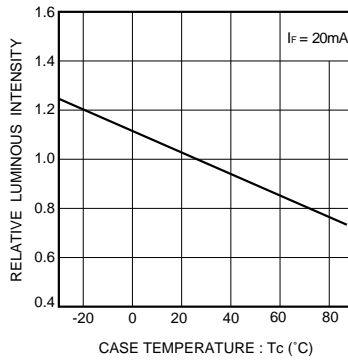

Fig. 15 Luminous intensity vs. case temperature

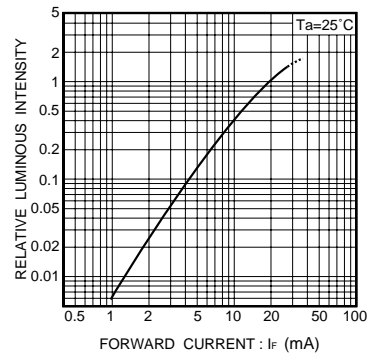

Fig. 16 Luminous intensity vs. forward current

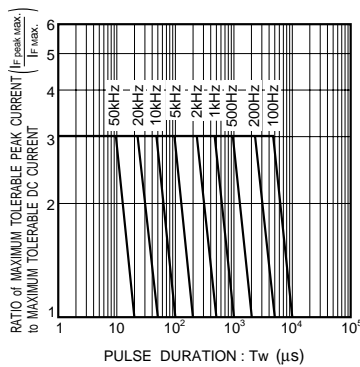

Fig. 17 Maximum tolerable peak current vs. pulse duration

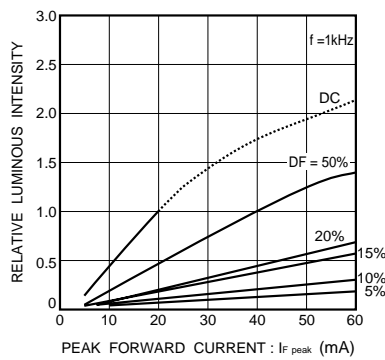

Fig. 18 Luminous intensity vs. peak forward current

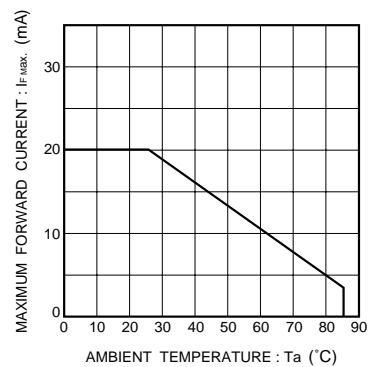

Fig. 19 Maximum forward current vs. ambient temperature

●Electrical characteristics curves 4 (SML-310YT) (yellow)

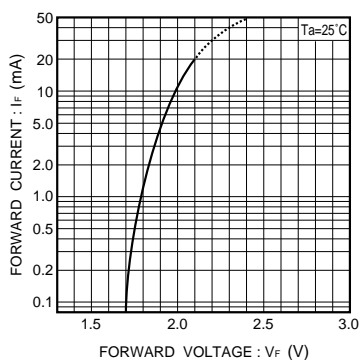

Fig. 20 Forward current vs. forward voltage

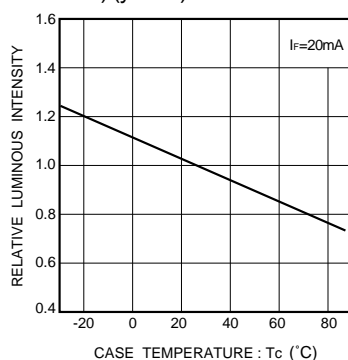

Fig. 21 Luminous intensity vs. case temperature

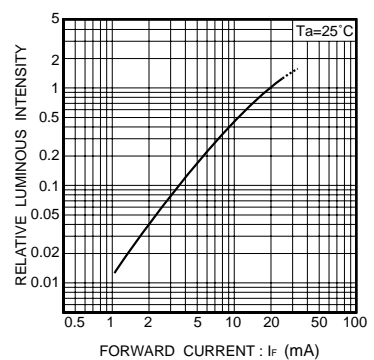

Fig. 22 Luminous intensity vs. forward current

LED lamps

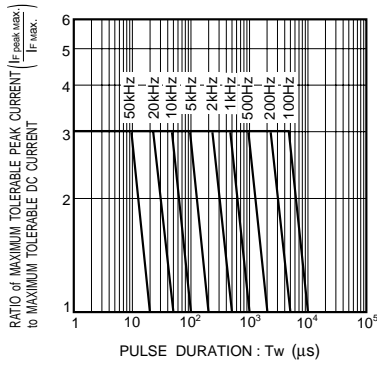

Fig. 23 Maximum tolerable peak current vs. pulse duration

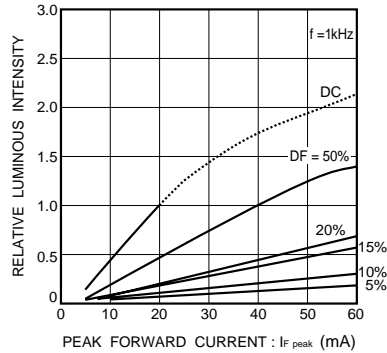

Fig. 24 Luminous intensity vs. peak forward current

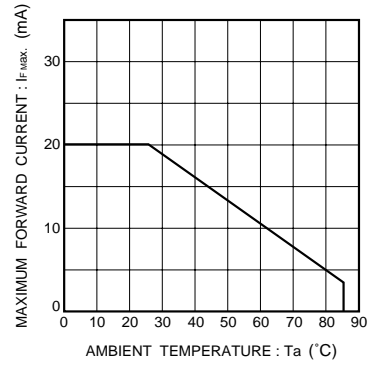

Fig. 25 Maximum forward current vs. ambient temperature

●Electrical characteristics curves 5 (SML-310MT, SML-310PT, SML-310FT) (green)

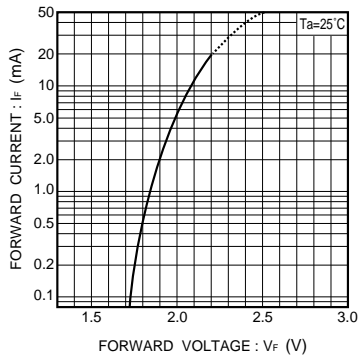

Fig. 26 Forward current vs. forward voltage

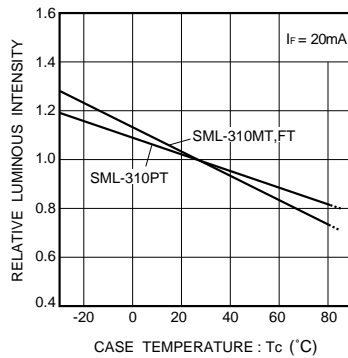

Fig. 27 Luminous intensity vs. case temperature

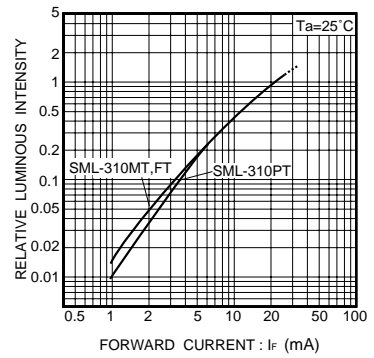

Fig. 28 Luminous intensity vs. forward current

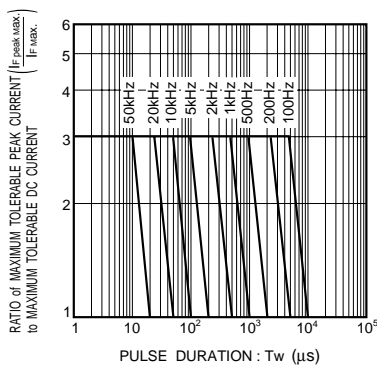

Fig. 29 Maximum tolerable peak current vs. pulse duration

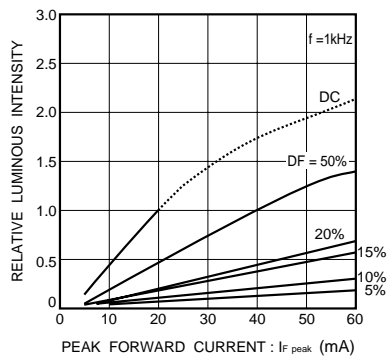

Fig. 30 Luminous intensity vs. peak forward current

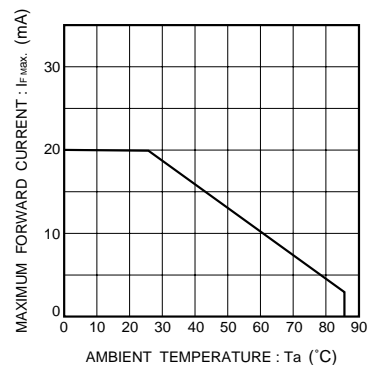

Fig. 31 Maximum forward current vs. ambient temperature

This datasheet has been download from:

[www.datasheetcatalog.com](http://www.datasheetcatalog.com)

Datasheets for electronics components.