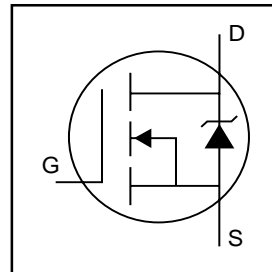


# IRLR/U014N

HEXFET® Power MOSFET

- Logic-Level Gate Drive
- Surface Mount (IRLR024N)
- Straight Lead (IRLU024N)
- Advanced Process Technology
- Fast Switching
- Fully Avalanche Rated

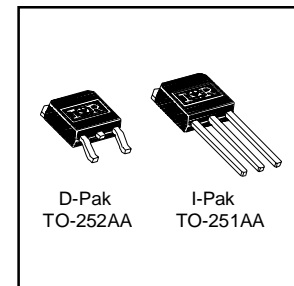


|                           |
|---------------------------|
| $V_{DSS} = 55V$           |
| $R_{DS(on)} = 0.14\Omega$ |
| $I_D = 10A$               |

## Description

Fifth Generation HEXFETs from International Rectifier utilize advanced processing techniques to achieve the lowest possible on-resistance per silicon area. This benefit, combined with the fast switching speed and ruggedized device design that HEXFET Power MOSFETs are well known for, provides the designer with an extremely efficient device for use in a wide variety of applications.

The D-PAK is designed for surface mounting using vapor phase, infrared, or wave soldering techniques. The straight lead version (IRFU series) is for through-hole mounting applications. Power dissipation levels up to 1.5 watts are possible in typical surface mount applications.



## Absolute Maximum Ratings

|                           | Parameter                                | Max.                   | Units |
|---------------------------|--|------------------------|-------|
| $I_D @ T_C = 25^\circ C$  | Continuous Drain Current, $V_{GS} @ 10V$ | 10                     | A     |
| $I_D @ T_C = 100^\circ C$ | Continuous Drain Current, $V_{GS} @ 10V$ | 7.1                    |       |
| $I_{DM}$                  | Pulsed Drain Current ①                   | 40                     |       |
| $P_D @ T_C = 25^\circ C$  | Power Dissipation                        | 28                     | W     |
|                           | Linear Derating Factor                   | 0.2                    | W/°C  |
| $V_{GS}$                  | Gate-to-Source Voltage                   | $\pm 16$               | V     |
| $E_{AS}$                  | Single Pulse Avalanche Energy②           | 35                     | mJ    |
| $I_{AR}$                  | Avalanche Current①                       | 6.0                    | A     |
| $E_{AR}$                  | Repetitive Avalanche Energy①             | 2.8                    | mJ    |
| dv/dt                     | Peak Diode Recovery dv/dt ③              | 5.0                    | V/ns  |
| $T_J$                     | Operating Junction and                   | -55 to + 175           | °C    |
| $T_{STG}$                 | Storage Temperature Range                |                        |       |
|                           | Soldering Temperature, for 10 seconds    | 300 (1.6mm from case ) |       |

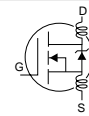
## Thermal Resistance

|                 | Parameter                     | Typ. | Max. | Units |
|-----------------|-------------------------------|------|------|-------|
| $R_{\theta JC}$ | Junction-to-Case              | —    | 5.3  | °C/W  |
| $R_{\theta JA}$ | Case-to-Ambient (PCB mount)** | —    | 50   |       |
| $R_{\theta JA}$ | Junction-to-Ambient           | —    | 110  |       |

\*\* When mounted on 1" square PCB (FR-4 or G-10 Material) .  
For recommended footprint and soldering techniques refer to application note #AN-994

## Electrical Characteristics @ $T_J = 25^\circ\text{C}$ (unless otherwise specified)

|                                 | Parameter                            | Min. | Typ.  | Max. | Units    | Conditions  |
|---------------------------------|--------------------------------------|------|-------|------|----------|---|
| $V_{(BR)DSS}$                   | Drain-to-Source Breakdown Voltage    | 55   | —     | —    | V        | $V_{GS} = 0V, I_D = 250\mu A$   |
| $\Delta V_{(BR)DSS}/\Delta T_J$ | Breakdown Voltage Temp. Coefficient  | —    | 0.056 | —    | V/°C     | Reference to $25^\circ\text{C}, I_D = 1\text{mA}$   |
| $R_{DS(on)}$                    | Static Drain-to-Source On-Resistance | —    | —     | 0.14 | $\Omega$ | $V_{GS} = 10V, I_D = 6A$ ④  |
|                                 |                                      | —    | —     | 0.21 |          | $V_{GS} = 4.5V, I_D = 5A$ ④   |
| $V_{GS(th)}$                    | Gate Threshold Voltage               | 1.0  | —     | —    | V        | $V_{DS} = V_{GS}, I_D = 250\mu A$   |
| $g_{fs}$                        | Forward Transconductance             | 3.1  | —     | —    | S        | $V_{DS} = 25V, I_D = 6A$ ⑦  |
| $I_{DSS}$                       | Drain-to-Source Leakage Current      | —    | —     | 25   | $\mu A$  | $V_{DS} = 55V, V_{GS} = 0V$   |
|                                 |                                      | —    | —     | 250  |          | $V_{DS} = 55V, V_{GS} = 0V, T_J = 150^\circ\text{C}$  |
| $I_{GSS}$                       | Gate-to-Source Forward Leakage       | —    | —     | 100  | nA       | $V_{GS} = 16V$  |
|                                 | Gate-to-Source Reverse Leakage       | —    | —     | -100 |          | $V_{GS} = -16V$   |
| $Q_g$                           | Total Gate Charge                    | —    | —     | 7.9  | nC       | $I_D = 6A$<br>$V_{DS} = 44V$<br>$V_{GS} = 5.0V$ , See Fig. 6 and 13 ④                                 |
| $Q_{gs}$                        | Gate-to-Source Charge                | —    | —     | 1.4  |          |   |
| $Q_{gd}$                        | Gate-to-Drain ("Miller") Charge      | —    | —     | 4.4  |          |   |
| $t_{d(on)}$                     | Turn-On Delay Time                   | —    | 6.5   | —    |          |   |
| $t_r$                           | Rise Time                            | —    | 47    | —    | ns       | $V_{DD} = 28V$<br>$I_D = 6A$<br>$R_G = 6.2\Omega, V_{GS} = 5.0V$<br>$R_D = 4.5\Omega$ , See Fig. 10 ④ |
| $t_{d(off)}$                    | Turn-Off Delay Time                  | —    | 12    | —    |          |   |
| $t_f$                           | Fall Time                            | —    | 23    | —    |          |   |
| $L_D$                           | Internal Drain Inductance            | —    | 4.5   | —    | nH       | Between lead,<br>6mm (0.25in.)<br>from package<br>and center of die contact ⑥                         |
| $L_S$                           | Internal Source Inductance           | —    | 7.5   | —    |          |   |
| $C_{iss}$                       | Input Capacitance                    | —    | 265   | —    | pF       | $V_{GS} = 0V$<br>$V_{DS} = 25V$<br>$f = 1.0\text{MHz}$ , See Fig. 5                                   |
| $C_{oss}$                       | Output Capacitance                   | —    | 80    | —    |          |   |
| $C_{rss}$                       | Reverse Transfer Capacitance         | —    | 38    | —    |          |   |



## Source-Drain Ratings and Characteristics

|          | Parameter                              | Min.  | Typ. | Max. | Units | Conditions   |
|----------|--|---|------|------|-------|--|
| $I_S$    | Continuous Source Current (Body Diode) | —   | —    | 10   | A     | MOSFET symbol showing the integral reverse p-n junction diode. |
| $I_{SM}$ | Pulsed Source Current (Body Diode) ①   | —   | —    | 40   |       |  |
| $V_{SD}$ | Diode Forward Voltage                  | —   | —    | 1.3  | V     | $T_J = 25^\circ\text{C}, I_S = 6A, V_{GS} = 0V$ ④              |
| $t_{rr}$ | Reverse Recovery Time                  | —   | 37   | 56   | nS    | $T_J = 25^\circ\text{C}, I_F = 6A$                             |
| $Q_{rr}$ | Reverse Recovery Charge                | —   | 48   | 71   | nC    | $di/dt = 100A/\mu s$ ④   |
| $t_{on}$ | Forward Turn-On Time                   | Intrinsic turn-on time is negligible (turn-on is dominated by $L_S + L_D$ ) |      |      |       |  |

### Notes:

① Repetitive rating; pulse width limited by max. junction temperature. ( See fig. 11 )

② Starting  $T_J = 25^\circ\text{C}$ ,  $L = 1.96\text{mH}$   
 $R_G = 25\Omega, I_{AS} = 6A$ . (See Figure 12)

③  $I_{SD} \leq 6.0A, di/dt \leq 210A/\mu s, V_{DD} \leq$

$V_{(BR)DSS}, T_J \leq 175^\circ\text{C}$   
2

④ Pulse width  $\leq 300\mu s$ ; duty cycle  $\leq 2\%$ .

⑤ This is applied for I-PAK,  $L_S$  of D-PAK is measured between lead and center of die contact

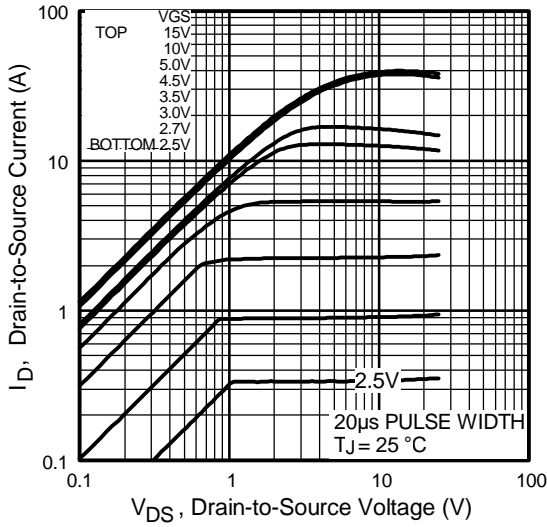


Fig 1. Typical Output Characteristics

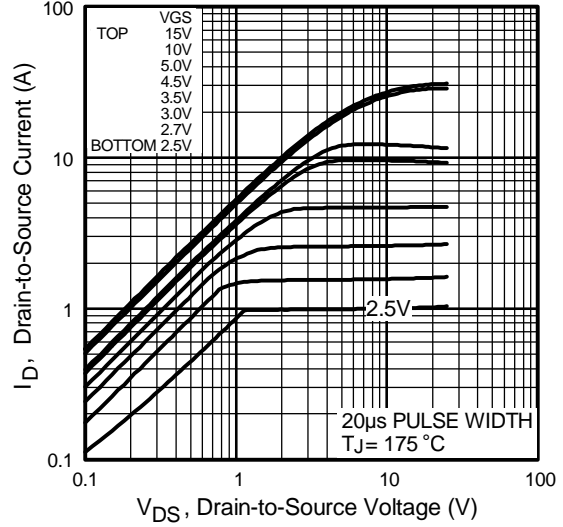


Fig 2. Typical Output Characteristics

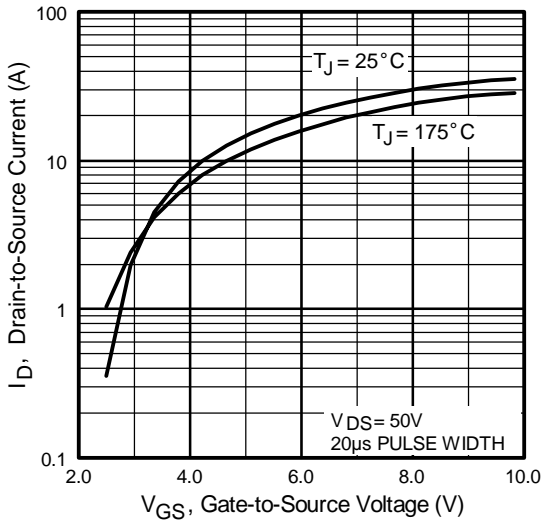


Fig 3. Typical Transfer Characteristics

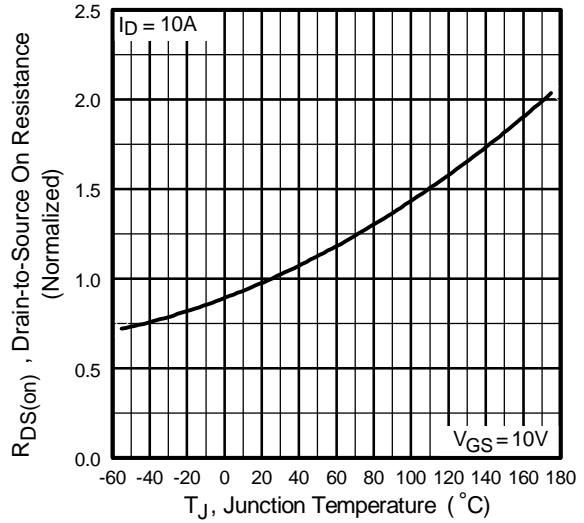
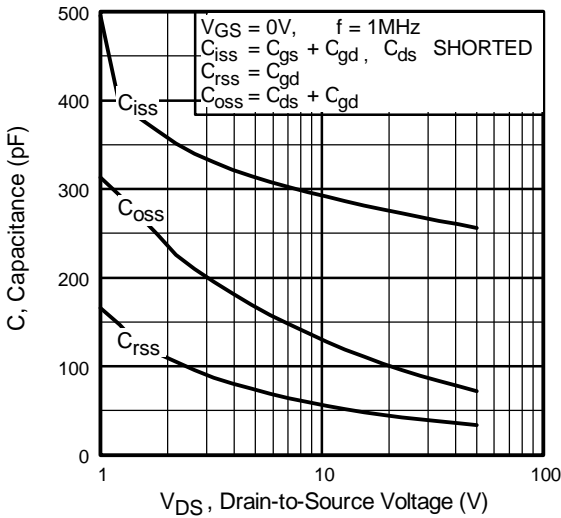
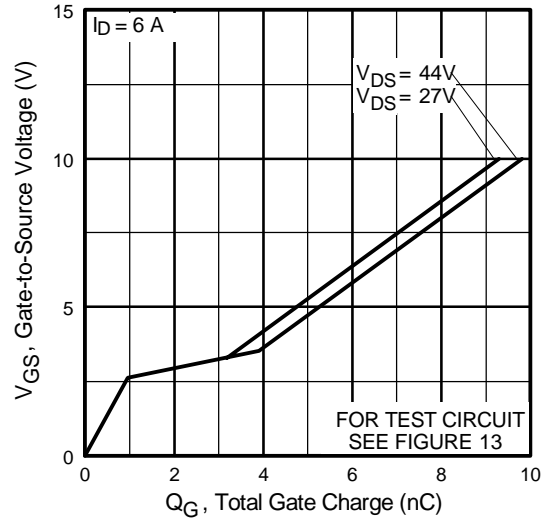


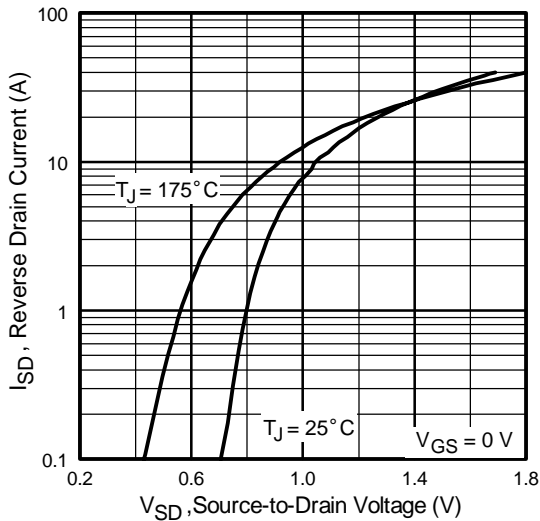
Fig 4. Normalized On-Resistance Vs. Temperature



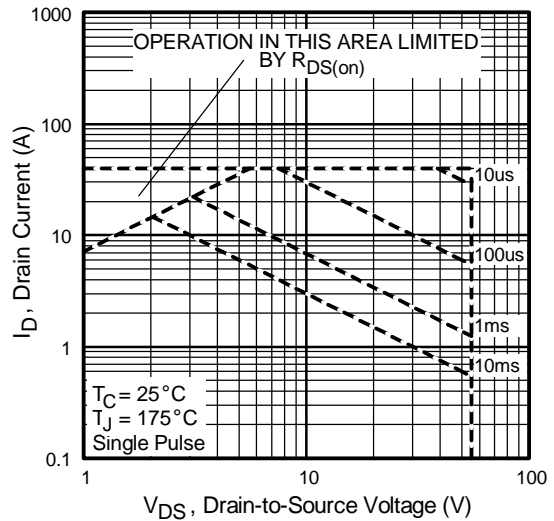
**Fig 5.** Typical Capacitance Vs. Drain-to-Source Voltage



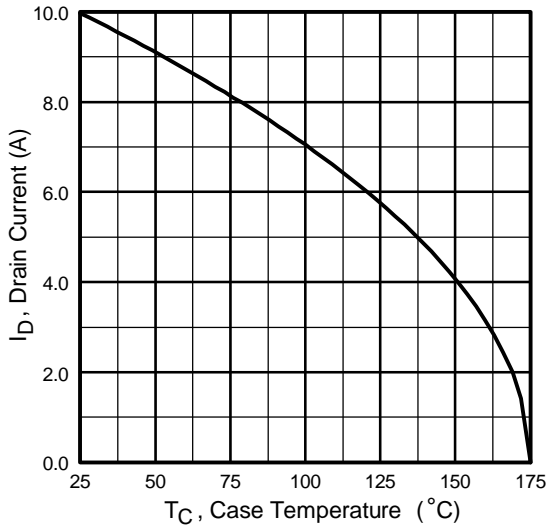
**Fig 6.** Typical Gate Charge Vs. Gate-to-Source Voltage



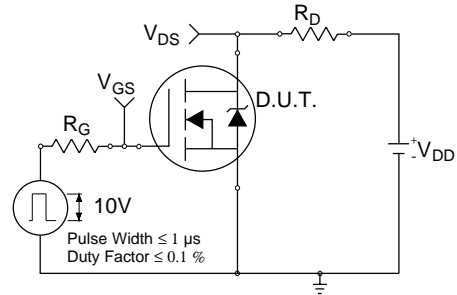
**Fig 7.** Typical Source-Drain Diode Forward Voltage



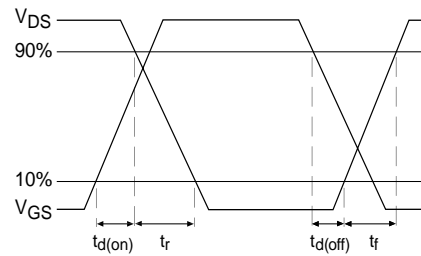
**Fig 8.** Maximum Safe Operating Area



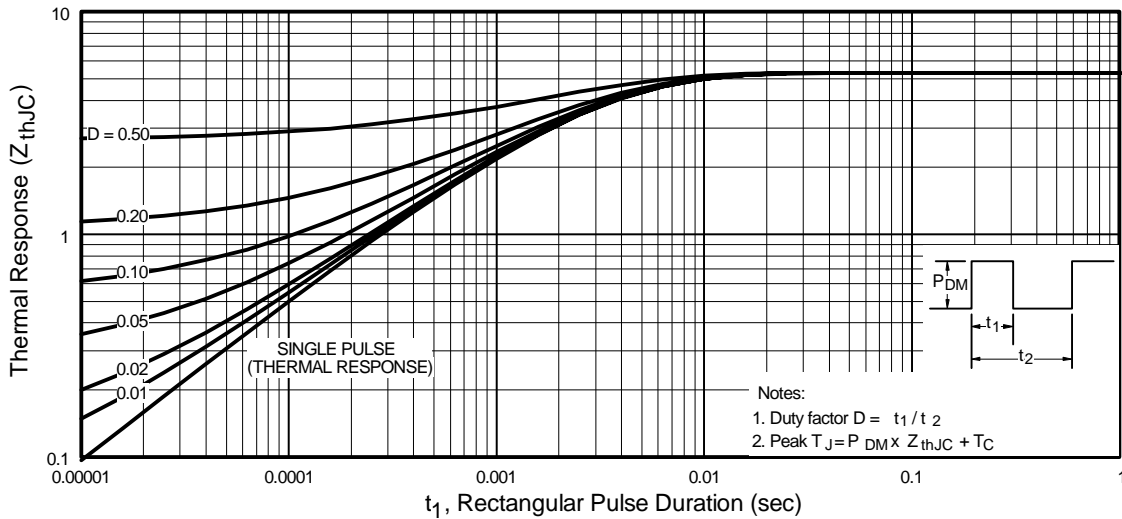
**Fig 9.** Maximum Drain Current Vs. Case Temperature



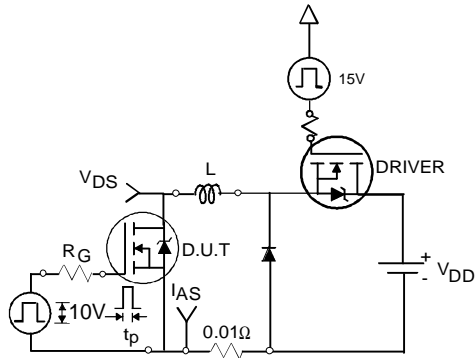
**Fig 10a.** Switching Time Test Circuit



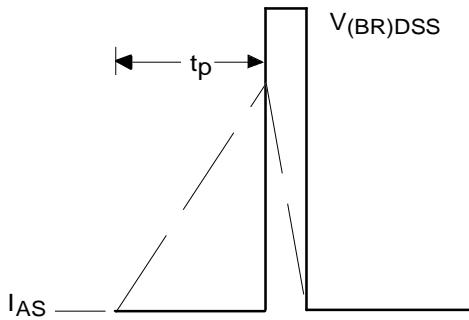
**Fig 10b.** Switching Time Waveforms



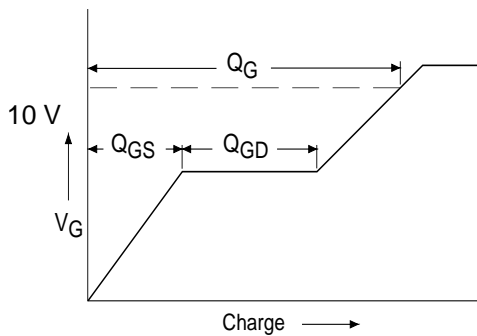
**Fig 11.** Maximum Effective Transient Thermal Impedance, Junction-to-Case



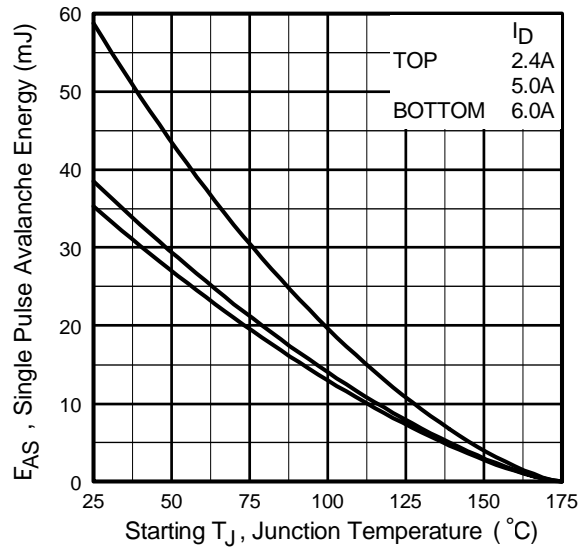
**Fig 12a.** Unclamped Inductive Test Circuit



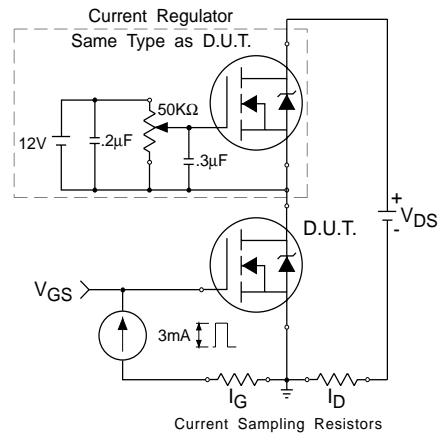
**Fig 12b.** Unclamped Inductive Waveforms



**Fig 13a.** Basic Gate Charge Waveform

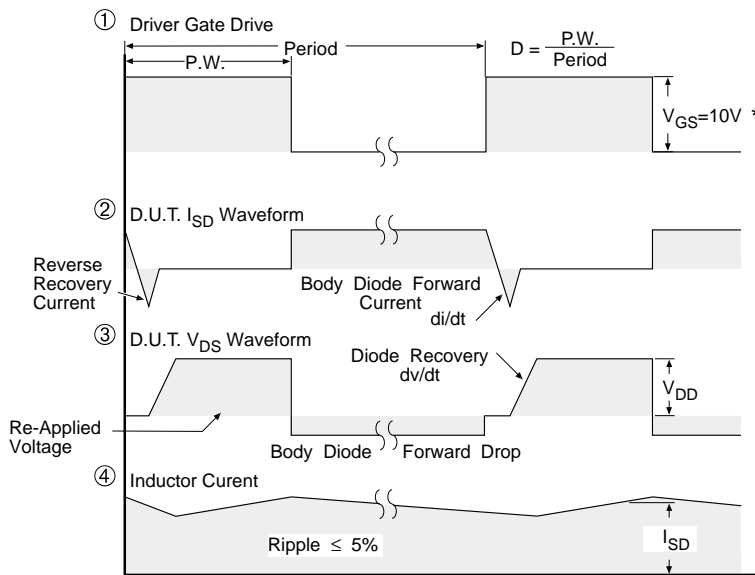
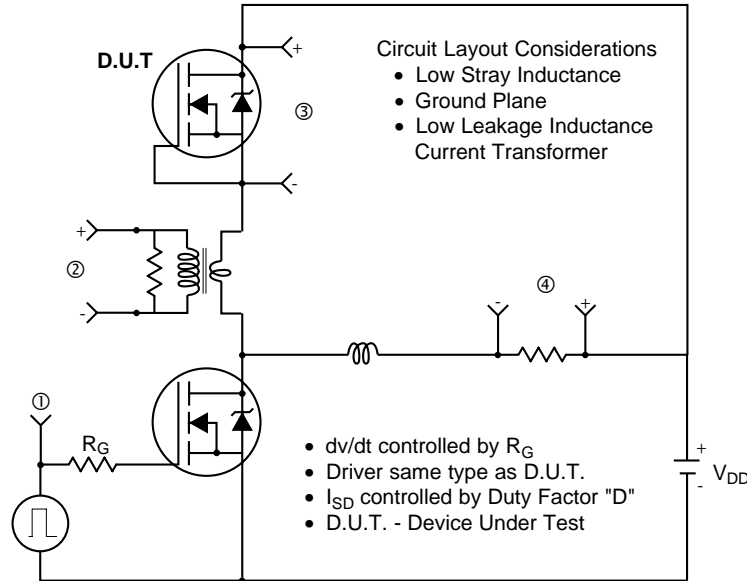


**Fig 12c.** Maximum Avalanche Energy Vs. Drain Current



**Fig 13b.** Gate Charge Test Circuit

**Peak Diode Recovery dv/dt Test Circuit**



\*  $V_{GS} = 5V$  for Logic Level Devices

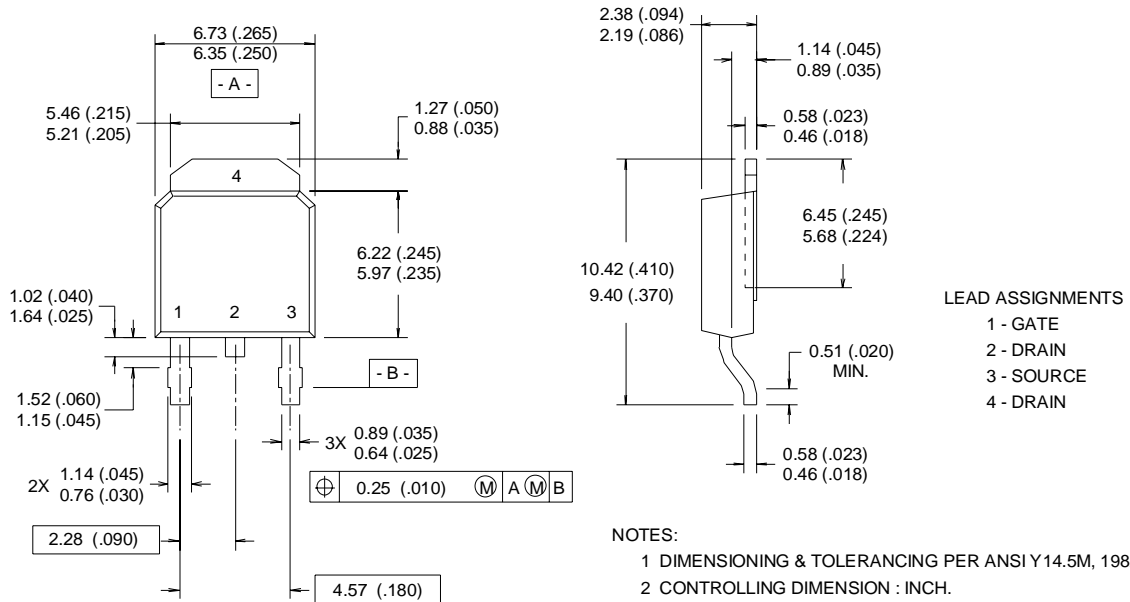
**Fig 14.** For N-Channel HEXFETS

# IRLR/U014N

## Package Outline

### TO-252AA Outline

Dimensions are shown in millimeters (inches)

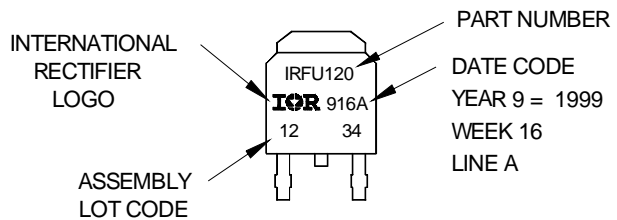


- NOTES:
- 1 DIMENSIONING & TOLERANCING PER ANSI Y14.5M, 1982.
  - 2 CONTROLLING DIMENSION : INCH.
  - 3 CONFORMS TO JEDEC OUTLINE TO-252AA.
  - 4 DIMENSIONS SHOWN ARE BEFORE SOLDER DIP, SOLDER DIP MAX. +0.16 (.006).

## Part Marking Information

### TO-252AA (D-PAK)

EXAMPLE: THIS IS AN IRFR120  
WITH ASSEMBLY  
LOT CODE 1234  
ASSEMBLED ON WW 16, 1999  
IN THE ASSEMBLY LINE "A"

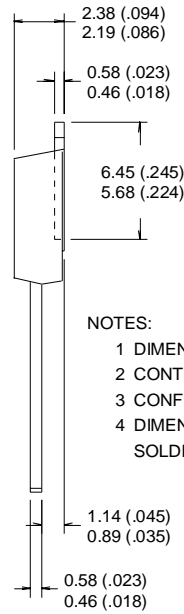
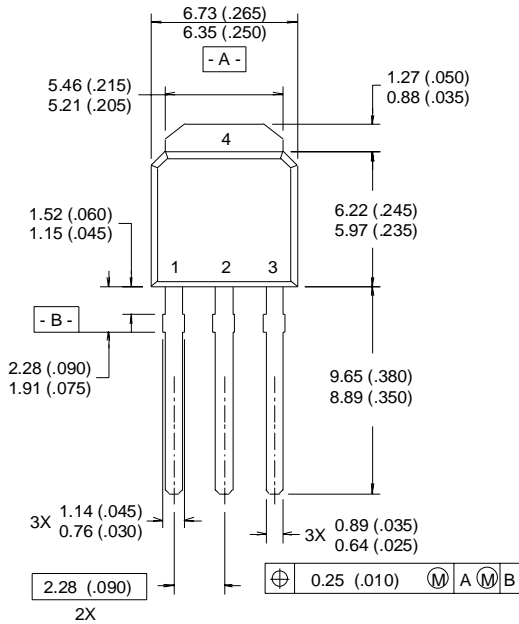




## Package Outline

### TO-251AA Outline

Dimensions are shown in millimeters (inches)



#### LEAD ASSIGNMENTS

- 1 - GATE
- 2 - DRAIN
- 3 - SOURCE
- 4 - DRAIN

#### NOTES:

- 1 DIMENSIONING & TOLERANCING PER ANSI Y14.5M, 1982.
- 2 CONTROLLING DIMENSION : INCH.
- 3 CONFORMS TO JEDEC OUTLINE TO-252AA.
- 4 DIMENSIONS SHOWN ARE BEFORE SOLDER DIP, SOLDER DIP MAX. +0.16 (.006).

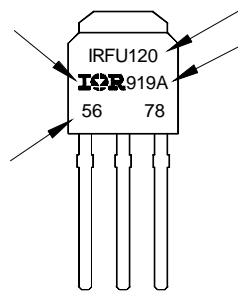
## Part Marking Information

### TO-251AA (I-PAK)

EXAMPLE: THIS IS AN IRFR120  
 WITH ASSEMBLY  
 LOT CODE 5678  
 ASSEMBLED ON WW 19, 1999  
 IN THE ASSEMBLY LINE "A"

INTERNATIONAL  
 RECTIFIER  
 LOGO

ASSEMBLY  
 LOT CODE



PART NUMBER  
 DATE CODE  
 YEAR 9 = 1999  
 WEEK 19  
 LINE A

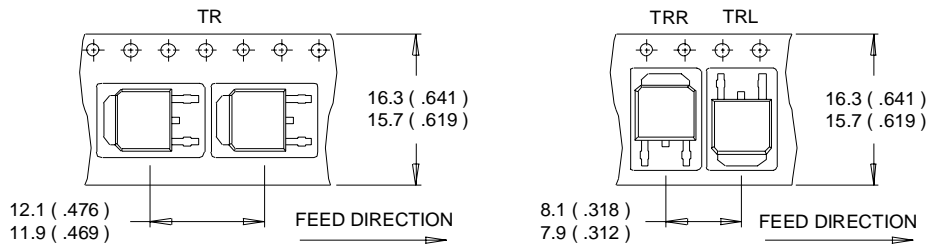
# IRLR/U014N

International  
**IR** Rectifier

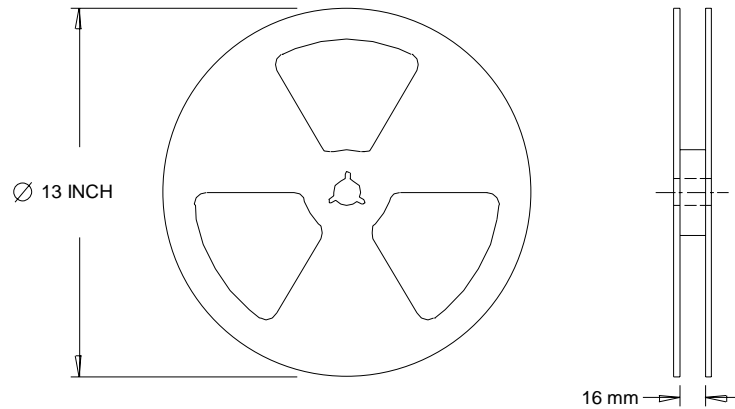
## Tape & Reel Information

### TO-252AA

Dimensions are shown in millimeters (inches)



- NOTES :
1. CONTROLLING DIMENSION : MILLIMETER.
  2. ALL DIMENSIONS ARE SHOWN IN MILLIMETERS ( INCHES ).
  3. OUTLINE CONFORMS TO EIA-481 & EIA-541.



- NOTES :
1. OUTLINE CONFORMS TO EIA-481.

Data and specifications subject to change without notice.  
This product has been designed and qualified for the Automotive[Q101] market.  
Qualification Standards can be found on IR's Web site.

International  
**IR** Rectifier

**IR WORLD HEADQUARTERS:** 233 Kansas St., El Segundo, California 90245, USA Tel: (310) 252-7105  
TAC Fax: (310) 252-7903

Visit us at [www.irf.com](http://www.irf.com) for sales contact information 5/99

[www.irf.com](http://www.irf.com)