

ILC5061

Power Supply reset Monitor with 1% Precision

Features

- All-CMOS design in SOT-23 or SC70 package
- $\pm 1\%$ precision in Reset Detection
- Only $1\mu\text{A}$ of I_q
- 2mA of sink current capability
- Built-in hysteresis of 5% of detection voltage
- Voltage options of 2.6, 2.9, 3.1, 4.4, and 4.6V fit most supervisory applications
- Open-Drain Reset Output

Applications

- Microprocessor reset circuits
- Memory battery back-up circuitry
- Power-on reset circuits
- Portable and battery powered electronics

Description

All-CMOS Monitor circuits in either a 3-lead SOT-23 or SC70 package offer the best performance in power consumption and accuracy.

The ILC5061 comes in a series of $\pm 1\%$ accurate trip voltages to fit most microprocessor applications. Even though its output can sink 2mA, the device draws only $1\mu\text{A}$ in normal operation.

Additionally, a built-in hysteresis of 5% of detect voltage simplifies system design.

Block Diagram

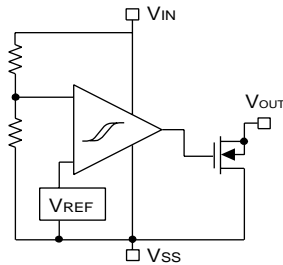

Pin Package Configurations

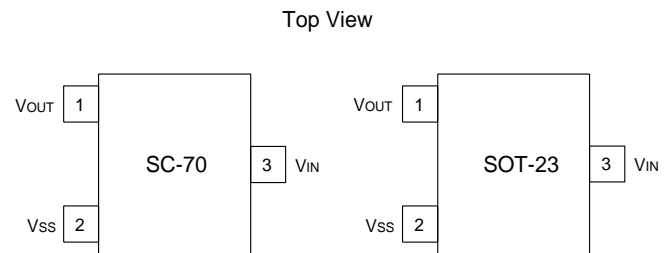

Absolute Maximum Ratings

| Parameter | | Symbol | Ratings | Units |
|------------------------------------|--------|-----------|-----------------------------|-------|
| Input Voltages | | V_{IN} | 12 | V |
| Output Current | | I_{OUT} | 50 | mA |
| Output Voltages | | V_{OUT} | $V_{SS}-0.3\sim+V_{IN}+0.3$ | V |
| Continuous Total Power Dissipation | SOT 23 | P_d | 150 | mW |
| Operation Ambient temperature | | T_{opr} | -30~+80 | °C |
| Storage Temperature | | T_{stg} | -40~+125 | °C |

Electrical Characteristics $T_A = 25^\circ\text{C}$

| Parameter | Symbol | Conditions | Min | Type | Max | Units |
|--|---|---|----------------------|------------------------------------|---------------------------------|---------------|
| Detect Fail Voltage | V_{DF} | | $V_{DF} \times 0.99$ | V_{DF} | $V_{DF} \times 1.01$ | V |
| Hysteresis Range | V_{HYS} | | $V_{DF} \times 0.02$ | $V_{DF} \times 0.05$ | $V_{DF} \times 0.08$ | V |
| Supply Current | I_{SS} | $V_{IN} = 1.5\text{V}$ $V_{IN} = 2.0\text{V}$ $V_{IN} = 3.0\text{V}$ $V_{IN} = 4.0\text{V}$ $V_{IN} = 5.0\text{V}$ | | 0.9 1.0 1.3 1.6 2.0 | 2.6 3.0 3.4 3.8 4.2 | μA |
| Operating Voltage | V_{IN} | $V_{DF} = 2.1\sim 6.0\text{V}$ | 1.5 | | 10.0 | V |
| Output Current | I_{OUT} | N-ch $V_{DS} = 0.5\text{V}$ $V_{IN} = 1.0\text{V}$ $V_{IN} = 2.0\text{V}$ $V_{IN} = 3.0\text{V}$ $V_{IN} = 4.0\text{V}$ $V_{IN} = 5.0\text{V}$ | | 2.2 7.7 10.1 11.5 13.0 | | mA |
| Temperature Characteristics | $DV_{DF}/(DT_{opr} * V_{DF})$ | $-30^\circ\text{C} \leq T_{opr} \leq 80^\circ\text{C}$ | -200 | ± 100 | +200 | Ppm/°C |
| Delay Time Release Voltage Output Inversion) | T_{DLY} (V_{DR} to V_{OUT} inversion) | | | | 0.1 | ms |

Note:

1. An additional resistor between the V_{IN} pin and supply voltage may cause deterioration of the characteristics due to increasing V_{DR} .

Functional Description

The following designators 1~6 refer to the timing diagram below.

1. While the input voltage (V_{IN}) is higher than the detect voltage (V_{DF}), the V_{OUT} output pin is at high impedance state.
2. When the input V_{IN} voltage falls lower than V_{DF} , V_{OUT} drops near to ground voltage
3. If the input voltage further decreases below the minimum operating voltage (V_{MIN}), the V_{OUT} output becomes unstable. In this condition, if the V_{OUT} pin is pulled up, V_{OUT} indicates the V_{IN} voltage.
4. During an increase of the input voltage from the V_{SS} voltage, V_{OUT} is not stable in the voltage below the V_{MIN} . Exceeding that level, the output stays at the ground level (V_{SS}) between the minimum operating voltage (V_{MIN}) and the detect release voltage (V_{DR}).
5. If the input voltage increases more than V_{DR} , then the V_{OUT} output pin is at high impedance state.
6. The difference between V_{DR} and V_{DF} is the hysteresis in the system.

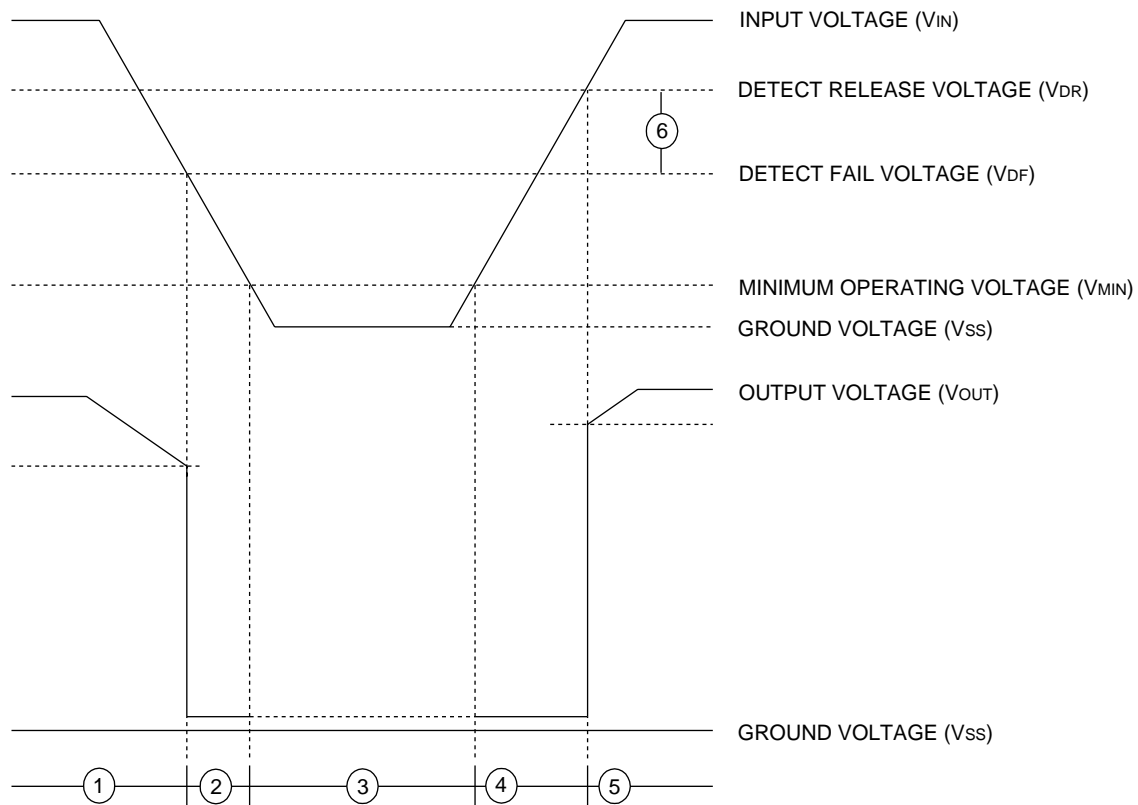

Typical Performance Characteristics (General conditions for all curves)

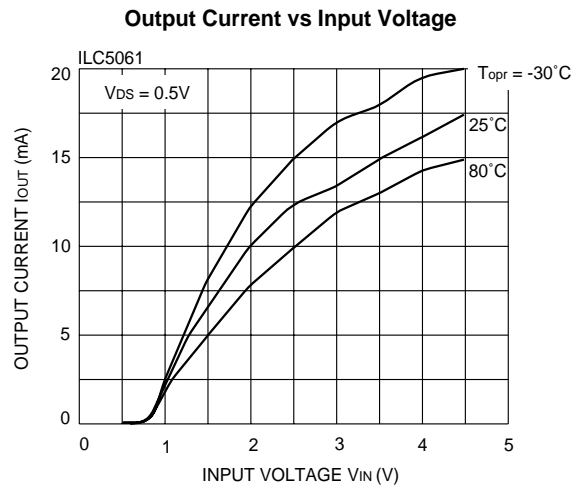
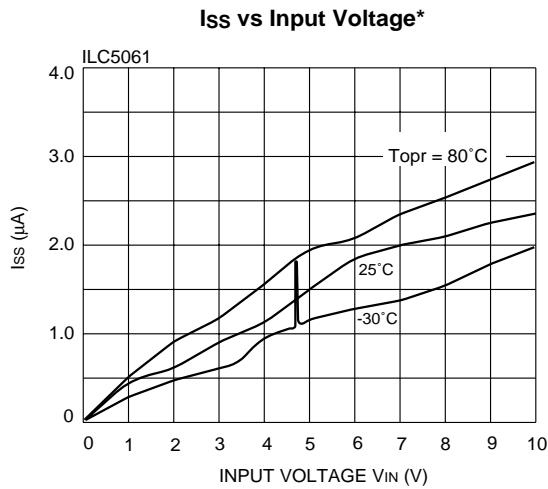
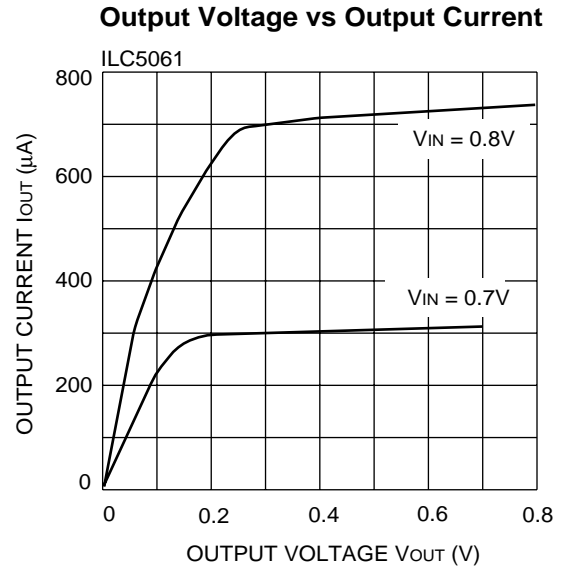
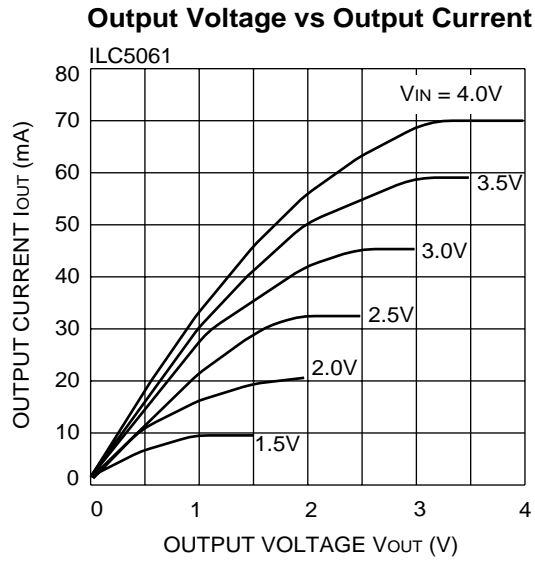

* A spike of 1/2 to 1 μ A may appear as V_{IN} crosses V_{DR} or V_{DF}

SOT-23 Package

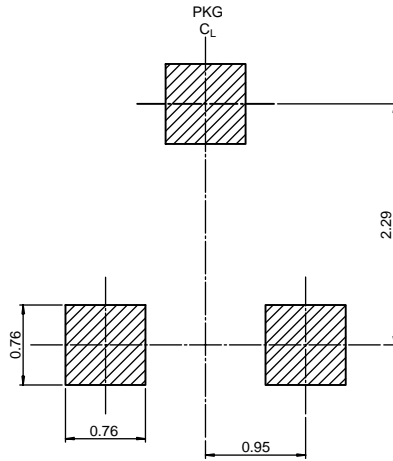
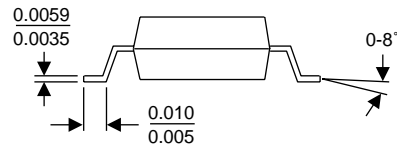
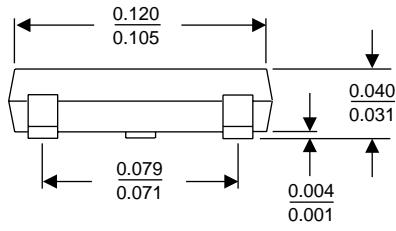
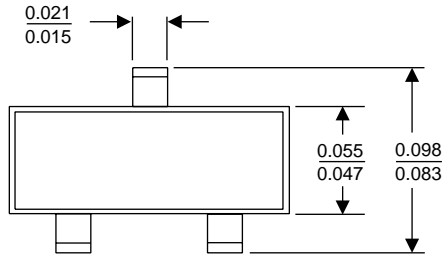

LAND PATTERN RECOMMENDATION

SC70 Package

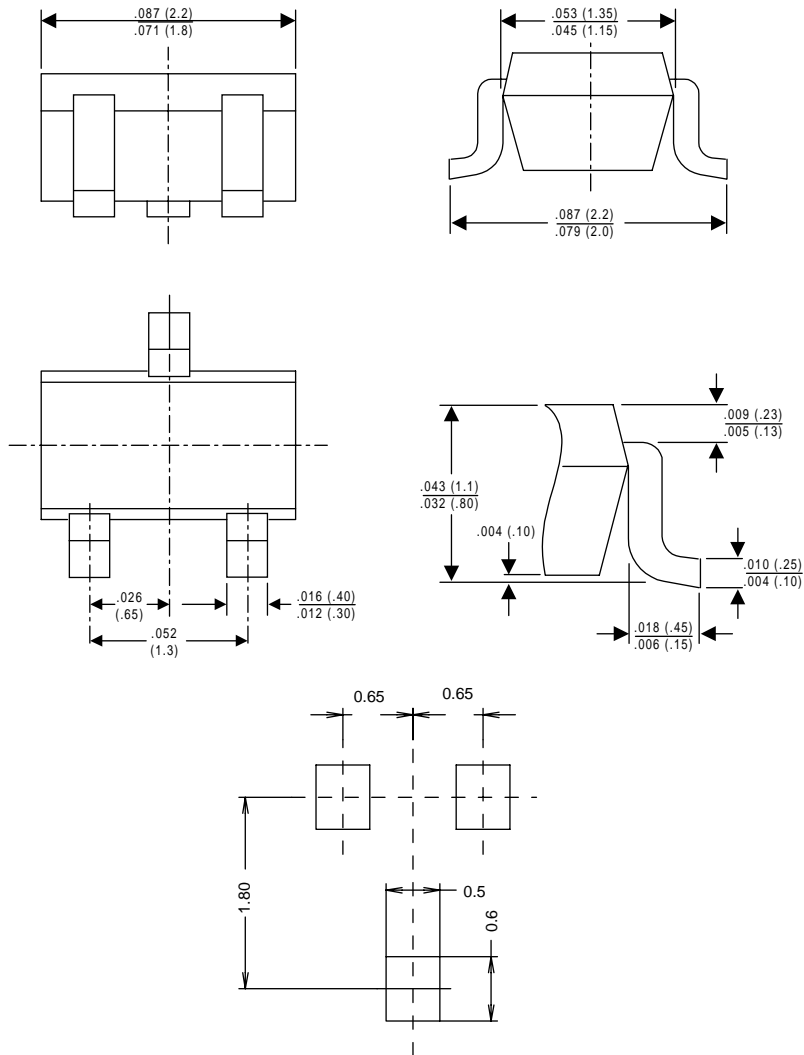

Land Pattern Recommendation

Ordering Information

| PART NUMBER | TOP MARKING | RESET THRESHOLD (V) | OUTPUT TYPE | PACKAGE | PACKING METHOD |
|--------------|-------------|---------------------|------------------------|--------------|-----------------|
| ILC5061AM23X | M3AY | 2.3 ± 1 % | Open-Drain, active low | 3-Pin, SOT23 | 3K units in T&R |
| ILC5061AM25X | M5AY | 2.5 ± 1 % | Open-Drain, active low | 3-Pin, SOT23 | 3K units in T&R |
| ILC5061AM26X | M6AY | 2.6 ± 1 % | Open-Drain, active low | 3-Pin, SOT23 | 3K units in T&R |
| ILC5061AM27X | M7AY | 2.7 ± 1 % | Open-Drain, active low | 3-Pin, SOT23 | 3K units in T&R |
| ILC5061AM28X | M8AY | 2.8 ± 1 % | Open-Drain, active low | 3-Pin, SOT23 | 3K units in T&R |
| ILC5061AM29X | M9AY | 2.9 ± 1 % | Open-Drain, active low | 3-Pin, SOT23 | 3K units in T&R |
| ILC5061AM31X | N1AY | 3.1 ± 1 % | Open-Drain, active low | 3-Pin, SOT23 | 3K units in T&R |
| ILC5061AM32X | N2AY | 3.2 ± 1 % | Open-Drain, active low | 3-Pin, SOT23 | 3K units in T&R |
| ILC5061AM34X | N4AY | 3.4 ± 1 % | Open-Drain, active low | 3-Pin, SOT23 | 3K units in T&R |
| ILC5061AM37X | N7AY | 3.7 ± 1 % | Open-Drain, active low | 3-Pin, SOT23 | 3K units in T&R |
| ILC5061AM44X | P4AY | 4.4 ± 1 % | Open-Drain, active low | 3-Pin, SOT23 | 3K units in T&R |
| ILC5061AM46X | P6AY | 4.6 ± 1 % | Open-Drain, active low | 3-Pin, SOT23 | 3K units in T&R |
| ILC5061M23X | M3Y | 2.3 ± 2 % | Open-Drain, active low | 3-Pin, SOT23 | 3K units in T&R |
| ILC5061M25X | M5Y | 2.5 ± 2 % | Open-Drain, active low | 3-Pin, SOT23 | 3K units in T&R |
| ILC5061M26X | M6Y | 2.6 ± 2 % | Open-Drain, active low | 3-Pin, SOT23 | 3K units in T&R |
| ILC5061M27X | M7Y | 2.7 ± 2 % | Open-Drain, active low | 3-Pin, SOT23 | 3K units in T&R |
| ILC5061M28X | M8Y | 2.8 ± 2 % | Open-Drain, active low | 3-Pin, SOT23 | 3K units in T&R |
| ILC5061M29X | M9Y | 2.9 ± 2 % | Open-Drain, active low | 3-Pin, SOT23 | 3K units in T&R |
| ILC5061M31X | N1Y | 3.1 ± 2 % | Open-Drain, active low | 3-Pin, SOT23 | 3K units in T&R |
| ILC5061M32X | N2Y | 3.2 ± 2 % | Open-Drain, active low | 3-Pin, SOT23 | 3K units in T&R |
| ILC5061M34X | N4Y | 3.4 ± 2 % | Open-Drain, active low | 3-Pin, SOT23 | 3K units in T&R |
| ILC5061M37X | N7Y | 3.7 ± 2 % | Open-Drain, active low | 3-Pin, SOT23 | 3K units in T&R |
| ILC5061M44X | P4Y | 4.4 ± 2 % | Open-Drain, active low | 3-Pin, SOT23 | 3K units in T&R |
| ILC5061M46X | P6Y | 4.6 ± 2 % | Open-Drain, active low | 3-Pin, SOT23 | 3K units in T&R |

Note 1:Last digit in the "Top Marking" information (represented by "Y" in the above table) represents internal assembly lot number

Note 2:Orientation of Tape & Reeled devices is Right.

Ordering Information

| PART NUMBER | TOP MARKING | RESET THRESHOLD (V) | OUTPUT TYPE | PACKAGE | PACKING METHOD |
|---------------|-------------|---------------------|------------------------|-------------|-----------------|
| ILC5061AIC23X | M3AY | 2.3 ± 1 % | Open-Drain, active low | 3-Pin, SC70 | 3K units in T&R |
| ILC5061AIC25X | M5AY | 2.5 ± 1 % | Open-Drain, active low | 3-Pin, SC70 | 3K units in T&R |
| ILC5061AIC26X | M6AY | 2.6 ± 1 % | Open-Drain, active low | 3-Pin, SC70 | 3K units in T&R |
| ILC5061AIC27X | M7AY | 2.7 ± 1 % | Open-Drain, active low | 3-Pin, SC70 | 3K units in T&R |
| ILC5061AIC28X | M8AY | 2.8 ± 1 % | Open-Drain, active low | 3-Pin, SC70 | 3K units in T&R |
| ILC5061AIC29X | M9AY | 2.9 ± 1 % | Open-Drain, active low | 3-Pin, SC70 | 3K units in T&R |
| ILC5061AIC31X | N1AY | 3.1 ± 1 % | Open-Drain, active low | 3-Pin, SC70 | 3K units in T&R |
| ILC5061AIC32X | N2AY | 3.2 ± 1 % | Open-Drain, active low | 3-Pin, SC70 | 3K units in T&R |
| ILC5061AIC34X | N4AY | 3.4 ± 1 % | Open-Drain, active low | 3-Pin, SC70 | 3K units in T&R |
| ILC5061AIC37X | N7AY | 3.7 ± 1 % | Open-Drain, active low | 3-Pin, SC70 | 3K units in T&R |
| ILC5061AIC44X | P4AY | 4.4 ± 1 % | Open-Drain, active low | 3-Pin, SC70 | 3K units in T&R |
| ILC5061AIC46X | P6AY | 4.6 ± 1 % | Open-Drain, active low | 3-Pin, SC70 | 3K units in T&R |
| ILC5061IC23X | M3Y | 2.3 ± 2 % | Open-Drain, active low | 3-Pin, SC70 | 3K units in T&R |
| ILC5061IC25X | M5Y | 2.5 ± 2 % | Open-Drain, active low | 3-Pin, SC70 | 3K units in T&R |
| ILC5061IC26X | M6Y | 2.6 ± 2 % | Open-Drain, active low | 3-Pin, SC70 | 3K units in T&R |
| ILC5061IC27X | M7Y | 2.7 ± 2 % | Open-Drain, active low | 3-Pin, SC70 | 3K units in T&R |
| ILC5061IC28X | M8Y | 2.8 ± 2 % | Open-Drain, active low | 3-Pin, SC70 | 3K units in T&R |
| ILC5061IC29X | M9Y | 2.9 ± 2 % | Open-Drain, active low | 3-Pin, SC70 | 3K units in T&R |
| ILC5061IC31X | N1Y | 3.1 ± 2 % | Open-Drain, active low | 3-Pin, SC70 | 3K units in T&R |
| ILC5061IC32X | N2Y | 3.2 ± 2 % | Open-Drain, active low | 3-Pin, SC70 | 3K units in T&R |
| ILC5061IC34X | N4Y | 3.4 ± 2 % | Open-Drain, active low | 3-Pin, SC70 | 3K units in T&R |
| ILC5061IC37X | N7Y | 3.7 ± 2 % | Open-Drain, active low | 3-Pin, SC70 | 3K units in T&R |
| ILC5061IC44X | P4Y | 4.4 ± 2 % | Open-Drain, active low | 3-Pin, SC70 | 3K units in T&R |
| ILC5061IC46X | P6Y | 4.6 ± 2 % | Open-Drain, active low | 3-Pin, SC70 | 3K units in T&R |

Note 1: Last digit in the "Top Marking" information (represented by "Y" in the above table) represents internal assembly lot number

Note 2: Orientation of Tape & Reeled devices is Right.

DISCLAIMER

FAIRCHILD SEMICONDUCTOR RESERVES THE RIGHT TO MAKE CHANGES WITHOUT FURTHER NOTICE TO ANY PRODUCTS HEREIN TO IMPROVE RELIABILITY, FUNCTION OR DESIGN. FAIRCHILD DOES NOT ASSUME ANY LIABILITY ARISING OUT OF THE APPLICATION OR USE OF ANY PRODUCT OR CIRCUIT DESCRIBED HEREIN; NEITHER DOES IT CONVEY ANY LICENSE UNDER ITS PATENT RIGHTS, NOR THE RIGHTS OF OTHERS.

LIFE SUPPORT POLICY

FAIRCHILD'S PRODUCTS ARE NOT AUTHORIZED FOR USE AS CRITICAL COMPONENTS IN LIFE SUPPORT DEVICES OR SYSTEMS WITHOUT THE EXPRESS WRITTEN APPROVAL OF THE PRESIDENT OF FAIRCHILD SEMICONDUCTOR CORPORATION. As used herein:

1. Life support devices or systems are devices or systems which, (a) are intended for surgical implant into the body, or (b) support or sustain life, and (c) whose failure to perform when properly used in accordance with instructions for use provided in the labeling, can be reasonably expected to result in a significant injury of the user.
2. A critical component in any component of a life support device or system whose failure to perform can be reasonably expected to cause the failure of the life support device or system, or to affect its safety or effectiveness.