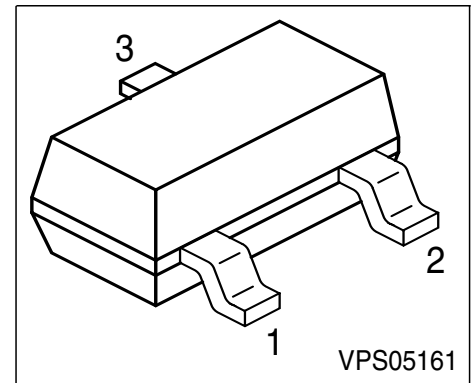
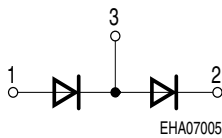
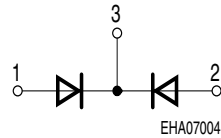
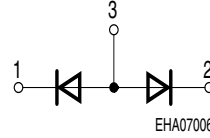

Silicon PIN Diodes

- RF switch, RF attenuator for frequencies above 10 MHz
- Low distortion faktor
- Long-term stability of electrical characteristics

BAR 14-1

BAR 15-1

BAR 16-1

Type	Marking	Pin Configuration			Package
		1 = A1	2 = C2	3=C1/A2	
BAR 14-1	L7s	1 = A1	2 = C2	3=C1/A2	SOT-23
BAR 15-1	L8s	1 = A1	2 = A2	3 = C1/2	SOT-23
BAR 16-1	L9s	1 = C1	2 = C2	3 = A1/2	SOT-23

Maximum Ratings

Parameter	Symbol	Value	Unit
Diode reverse voltage	V_R	100	V
Forward current	I_F	140	mA
Total power dissipation, $T_S \leq 65^\circ\text{C}$	P_{tot}	250	mW
Junction temperature	T_j	150	°C
Operating temperature range	T_{op}	-55 ... 150	
Storage temperature	T_{stg}	-55 ... 150	

Thermal Resistance

Junction - ambient ¹⁾	R_{thJA}	≤ 500	K/W
Junction - soldering point	R_{thJS}	≤ 340	

1) Package mounted on alumina 15mm x 16.7mm x 0.7mm

Electrical Characteristics at $T_A = 25^\circ\text{C}$, unless otherwise specified.

Parameter	Symbol	Values			Unit
		min.	typ.	max.	
DC characteristics					
Reverse current $V_R = 50\text{ V}$	I_R	-	-	100	nA
Reverse current $V_R = 100\text{ V}$	I_R	-	-	1	μA
Forward voltage $I_F = 100\text{ mA}$	V_F	-	1.05	-	V
AC characteristics					
Diode capacitance $V_R = 0\text{ V}, f = 100\text{ MHz}$ $V_R = 50\text{ V}, f = 1\text{ MHz}$	C_T	- -	0.2 0.25	- 0.5	pF
Forward resistance $I_F = 0.01\text{ mA}, f = 100\text{ MHz}$ $I_F = 0.1\text{ mA}, f = 100\text{ MHz}$ $I_F = 1\text{ mA}, f = 100\text{ MHz}$ $I_F = 10\text{ mA}, f = 100\text{ MHz}$	r_f	- - - -	2800 380 45 7	- - - -	Ω
Zero bias conductance $V_R = 0\text{ V}, f = 100\text{ MHz}$	g_p	-	50	-	μS
Charge carrier life time $I_F = 10\text{ mA}, I_R = 6\text{ mA}, I_R = 3\text{ mA}$	τ_{rr}	0.7	1	-	μs

Forward current $I_F = f(V_F)$

$T_A = 25^\circ\text{C}$

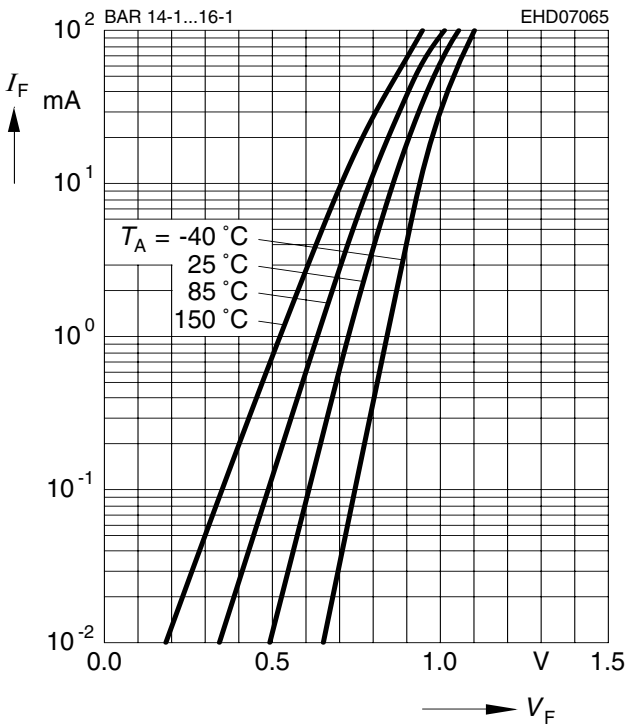

Forward current $I_F = f(T_A^*; T_S)$

* Package mounted on alumina

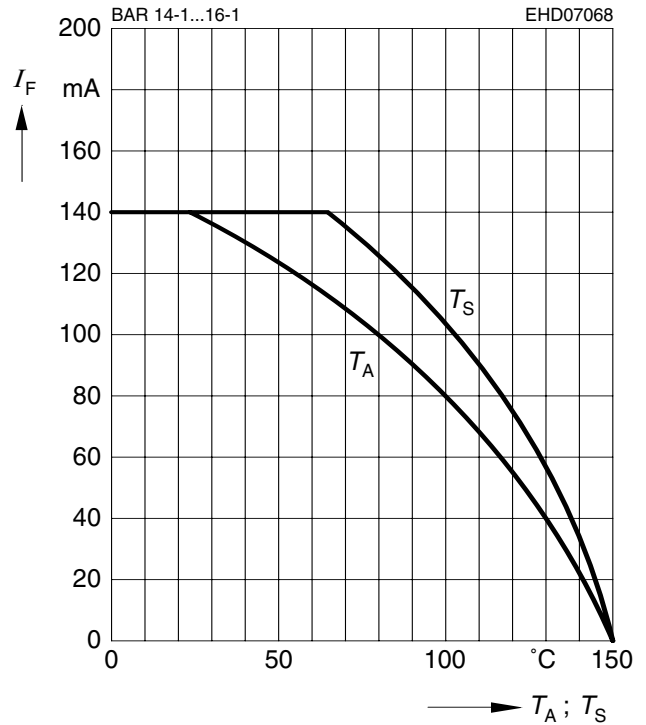

Forward resistance $r_f = f(I_F)$

$f = 100\text{MHz}$

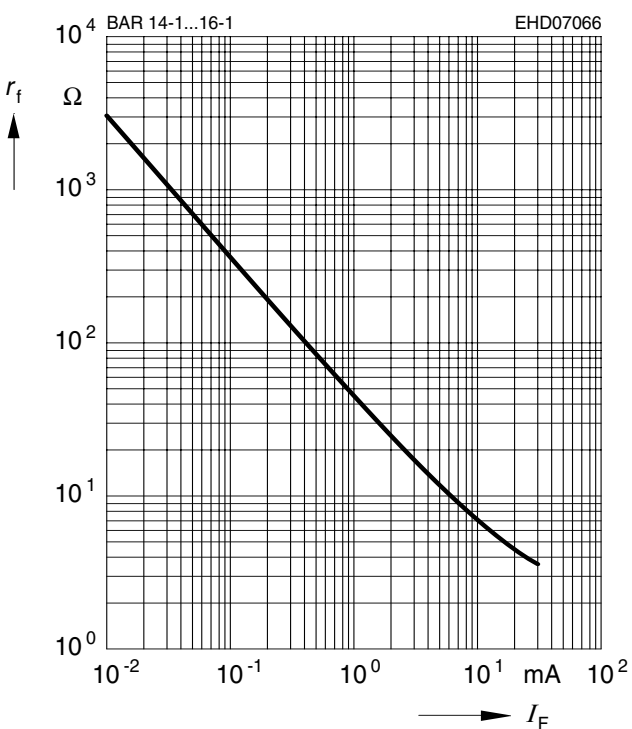

Diode capacitance $C_T = f(V_R)$

$f = \text{Parameter}$

