



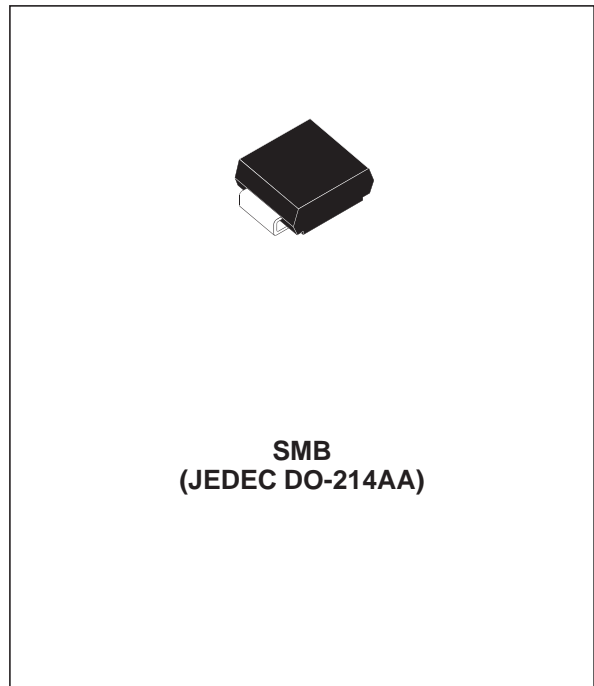
### FEATURES

- PEAK PULSE POWER : 600 W (10/1000μs)
- STAND OFF VOLTAGE RANGE :  
From 5V to 188V.
- UNI AND BIDIRECTIONAL TYPES
- LOW CLAMPING FACTOR
- FAST RESPONSE TIME
- JEDEC REGISTERED PACKAGE OUTLINE

### DESCRIPTION

The SMBJ series are TRANSIL™ diodes designed specifically for protecting sensitive equipment against transient overvoltages.

Transil diodes provide high overvoltage protection by clamping action. Their instantaneous response to transient overvoltages makes them particularly suited to protect voltage sensitive devices such as MOS Technology and low voltage supplied IC's.



### ABSOLUTE MAXIMUM RATINGS (T<sub>amb</sub> = 25°C)

Symbol	Parameter		Value	Unit
P <sub>PP</sub>	Peak pulse power dissipation (see note 1)	T <sub>j</sub> initial = T <sub>amb</sub>	600	W
P	Power dissipation on infinite heatsink	T <sub>amb</sub> = 50°C	5	W
I <sub>FSM</sub>	Non repetitive surge peak forward current for unidirectional types	t <sub>p</sub> = 10ms T <sub>j</sub> initial = T <sub>amb</sub>	100	A
T <sub>stg</sub> T <sub>j</sub>	Storage temperature range Maximum junction temperature		- 65 to + 175 150	°C °C
T <sub>L</sub>	Maximum lead temperature for soldering during 10 s.		260	°C

**Note 1** : For a surge greater than the maximum values, the diode will fail in short-circuit.

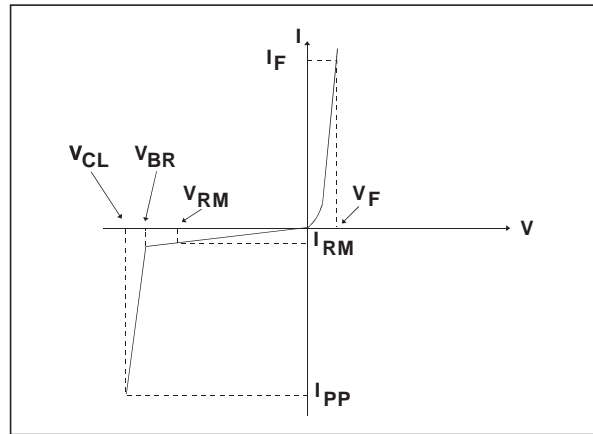
### THERMAL RESISTANCES

Symbol	Parameter	Value	Unit
R <sub>th (j-l)</sub>	Junction to leads	20	°C/W
R <sub>th (j-a)</sub>	Junction to ambient on printed circuit on recommended pad layout	100	°C/W

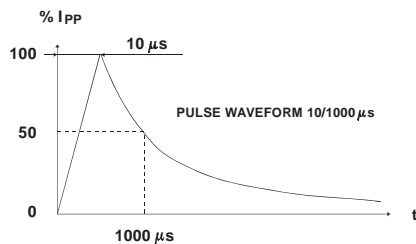
# SMBJxxxA-TR, CA-TR

## ELECTRICAL CHARACTERISTICS (T<sub>amb</sub> = 25°C)

Symbol	Parameter
V <sub>RM</sub>	Stand-off voltage
V <sub>BR</sub>	Breakdown voltage
V <sub>CL</sub>	Clamping voltage
I <sub>RM</sub>	Leakage current @ V <sub>RM</sub>
I <sub>PP</sub>	Peak pulse current
αT	Voltage temperature coefficient
V <sub>F</sub>	Forward voltage drop



Types				I <sub>RM</sub> @ V <sub>RM</sub> max.		V <sub>BR</sub> @ I <sub>R</sub> min. note2		V <sub>CL</sub> @ I <sub>PP</sub> max. 10/1000μs		V <sub>CL</sub> @ I <sub>PP</sub> max. 8/20μs		αT max. note3	C typ. note4
Unidirectional	Mark.	Bidirectional	Mark.	μA	V	V	mA	V	A	V	A	10 <sup>-4</sup> /°C	pF
SMBJ5.0A-TR	BUZ	SMBJ5.0CA-TR	BBZ	800	5.0	6.4	10	9.2	68	13.4	298	5.7	4000
SMBJ6.0A-TR	BUA	SMBJ6.0CA-TR	BBA	800	6.0	6.7	10	10.3	61	13.7	290	5.9	3850
SMBJ6.5A-TR	BUB	SMBJ6.5CA-TR	BBB	500	6.5	7.2	10	11.2	56	14.5	276	6.1	3700
SMBJ8.5A-TR	BUC	SMBJ8.5CA-TR	BBB	5	8.5	9.4	1	14.4	41.7	19.5	205	7.3	2800
SMBJ10A-TR	BUD	SMBJ10CA-TR	BBD	5	10	11.1	1	17	37	21.7	184	7.8	2300
SMBJ12A-TR	BUE	SMBJ12CA-TR	BBE	5	12	13.3	1	19.9	31	25.3	157	8.3	2025
SMBJ13A-TR	BUF	SMBJ13AC-TR	BBF	1	13	14.4	1	21.5	29	27.2	147	8.4	1900
SMBJ15A-TR	BUG	SMBJ15CA-TR	BBG	1	15	16.7	1	24.4	25.1	32.5	123	8.8	1600
SMBJ16A-TR	CUG	SMBJ16CA-TR	CBG	1	16	17.8	1	26	23.1	32.5	123	8.8	1600
SMBJ18A-TR	BUH	SMBJ18CA-TR	BBH	1	18	20	1	29.2	21.5	39.3	102	9.2	1350
SMBJ20A-TR	BUI	SMBJ20CA-TR	BBI	1	20	22.2	1	32.4	19.4	42.8	93	9.4	1250
SMBJ22A-TR	BVA	SMBJ22CA-TR	CBH	1	22	24.4	1	35.5	17.7	48.3	83	9.6	1150
SMBJ24A-TR	BUJ	SMBJ24CA-TR	BBJ	1	24	26.7	1	38.9	16	50	80	9.6	1112
SMBJ26A-TR	BUK	SMBJ26CA-TR	BBK	1	26	28.9	1	42.1	14.9	53.5	75	9.7	1075
SMBJ28A-TR	BUL	SMBJ28CA-TR	BBL	1	28	31.1	1	45.4	13.8	59	68	9.8	1000
SMBJ30A-TR	BUM	SMBJ30CA-TR	BBM	1	30	33.3	1	48.4	13	64.3	62	9.9	950
SMBJ33A-TR	BUN	SMBJ33CA-TR	BBN	1	33	36.7	1	53.3	11.8	69.7	57	10.0	900
SMBJ40A-TR	CUJ	SMBJ40CA-TR	CBJ	1	40	44.4	1	64.5	9.7	84	48	10.1	800
SMBJ48A-TR	BUW	SMBJ48CA-TR	BBW	1	48	53.3	1	77.4	8.1	100	40	10.3	700
SMBJ58A-TR	BUO	SMBJ58CA-TR	BBO	1	58	64.4	1	93.6	6.7	121	33	10.4	625
SMBJ70A-TR	CUM	SMBJ70CA-TR	CBM	1	70	77.8	1	113	5.5	146	27	10.5	550
SMBJ85A-TR	BUQ	SMBJ85CA-TR	BBQ	1	85	94.4	1	137	4.6	178	22.5	10.6	500
SMBJ100A-TR	CUQ	SMBJ100CA-TR	CBQ	1	100	111	1	162	3.8	212	19	10.7	450
SMBJ130A-TR	BUS	SMBJ130CA-TR	BBS	1	130	144	1	209	3	265	15	10.8	400
SMBJ154A-TR	BUT	SMBJ154CA-TR	BBT	1	154	171	1	246	2.4	317	12.6	10.8	360
SMBJ170A-TR	BUU	SMBJ170CA-TR	BBU	1	170	189	1	275	2.2	353	11.3	10.8	350
SMBJ188A-TR	BUV	SMBJ188CA-TR	BBV	1	188	209	1	328	2	388	10.3	10.8	330

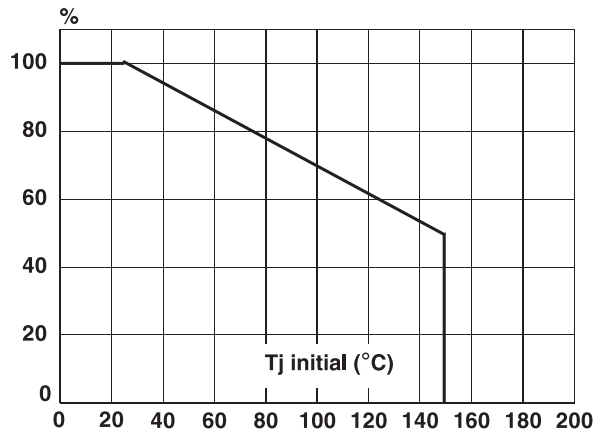


**Note 2 :** Pulse test : t<sub>p</sub> < 50 ms.

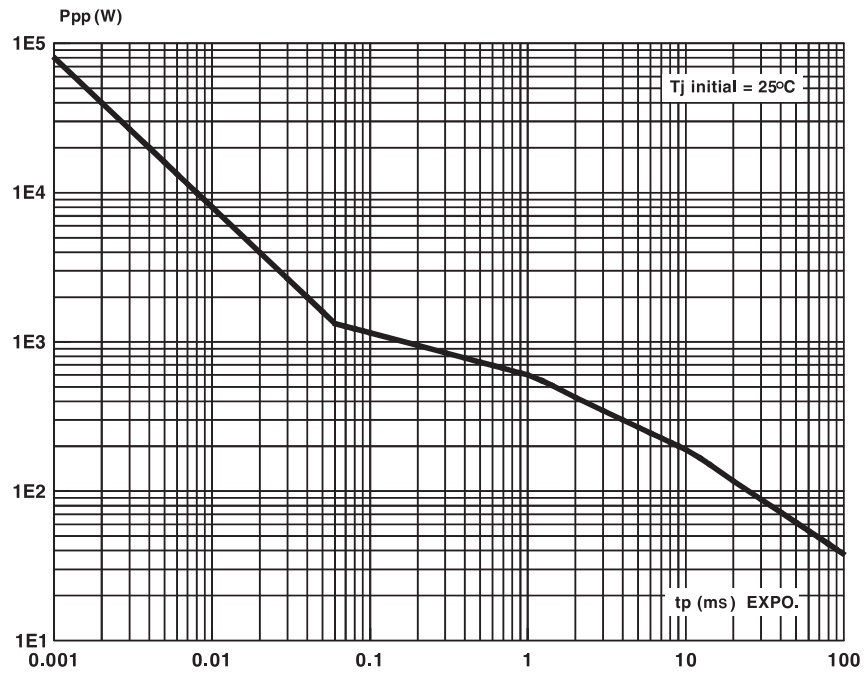
**Note 3 :** ΔV<sub>BR</sub> = αT \* (T<sub>amb</sub> - 25) \* V<sub>BR</sub>(25°C).

**Note 4 :** V<sub>R</sub> = 0 V, F = 1 MHz. For bidirectional types, capacitance value is divided by 2.

**Fig. 1:** Peak pulse power dissipation versus initial junction temperature (printed circuit board).

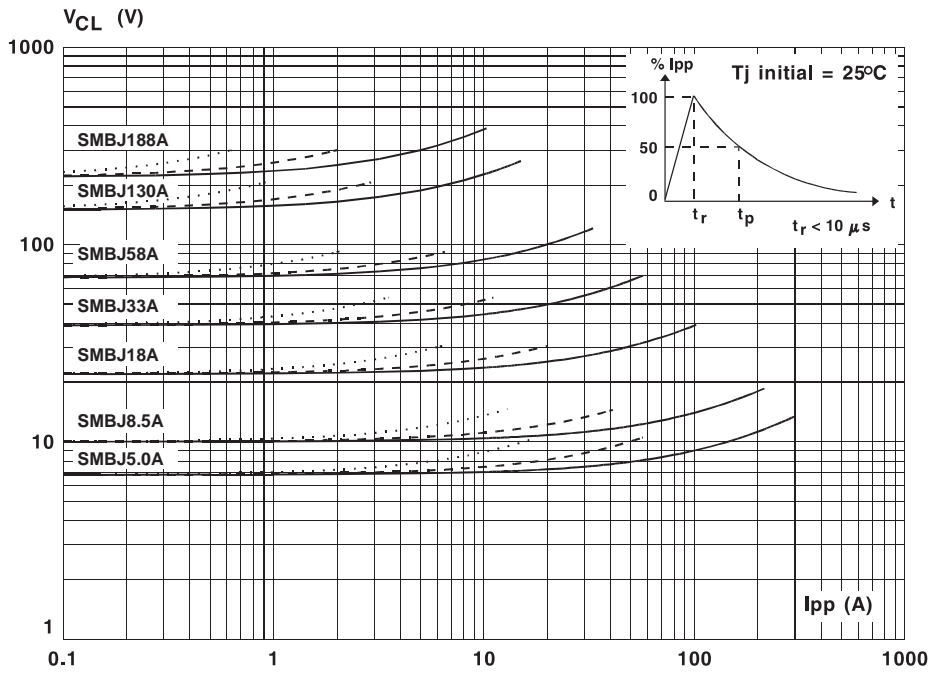


**Fig. 2 :** Peak pulse power versus exponential pulse duration.



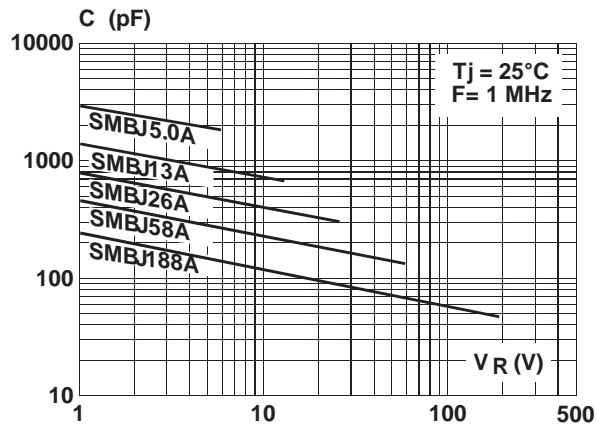
**SMBJxxxA-TR, CA-TR**

**Fig. 3 :** Clamping voltage versus peak pulse current.  
 Exponential waveform  $t_p = 20 \mu s$  \_\_\_\_\_  
 $t_p = 1 ms$  \_\_\_\_\_  
 $t_p = 10 ms$  .....

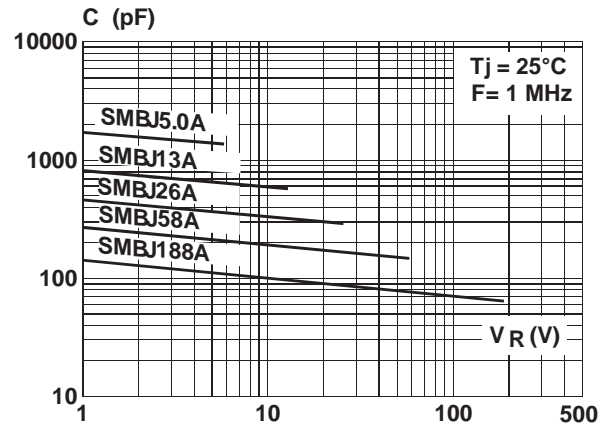


**Note :** The curves of the figure 3 are specified for a junction temperature of 25 °C before surge. The given results may be extrapolated for other junction temperatures by using the following formula :  
 $\Delta V_{BR} = \alpha T \cdot [T_{amb} - 25] \cdot V_{BR}(25^\circ C)$   
 For intermediate voltages, extrapolate the given results.

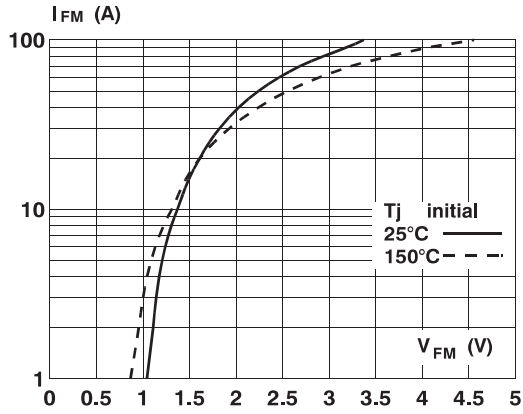
**Fig. 4a :** Capacitance versus reverse applied voltage for unidirectional types (typical values).



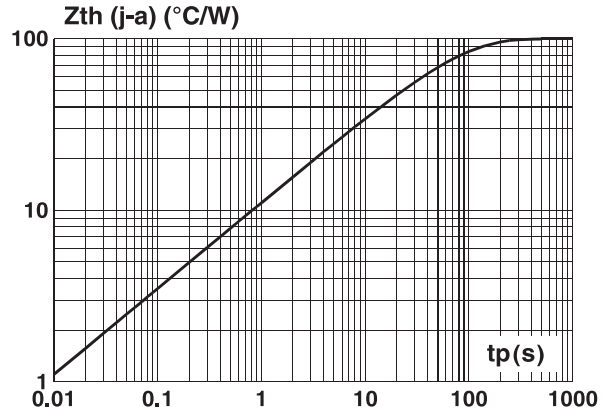
**Fig. 4b :** Capacitance versus reverse applied voltage for bidirectional types (typical values).



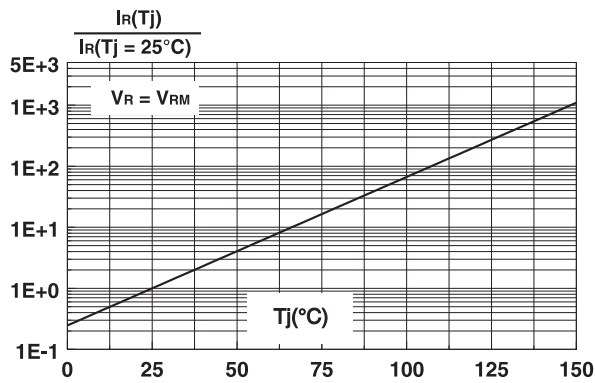
**Fig. 5 :** Peak forward voltage drop versus peak forward current (typical values for unidirectional types).



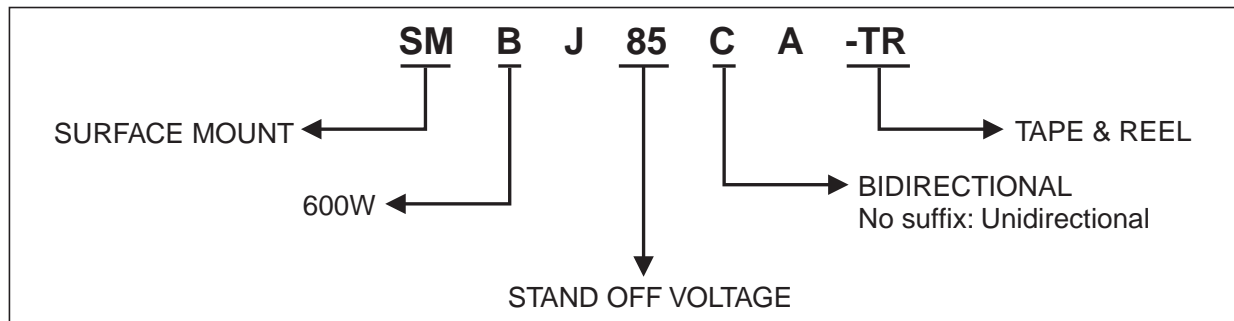
**Fig. 6 :** Transient thermal impedance junction-ambient versus pulse duration. Mounting on FR4 PC Board with Recommended pad layout.



**Fig. 7 :** Relative variation of leakage current versus junction temperature.



**ORDER CODE**

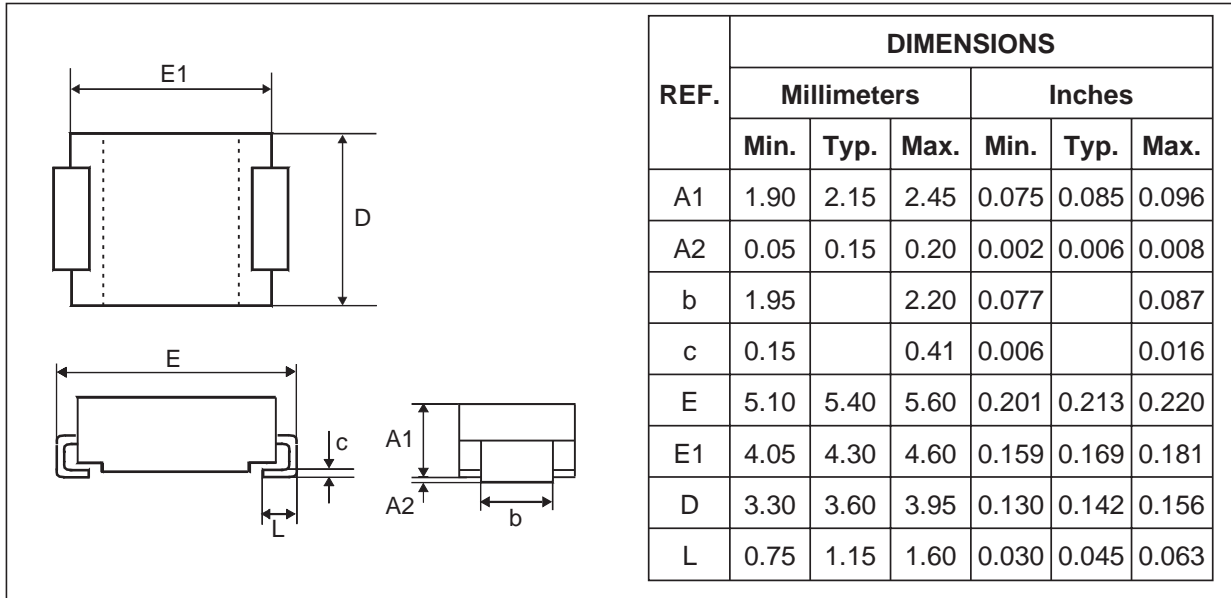


**SMBJxxxA-TR, CA-TR**

**MARKING** : Logo, Date Code, Type Code, Cathode Band (for unidirectional types only).

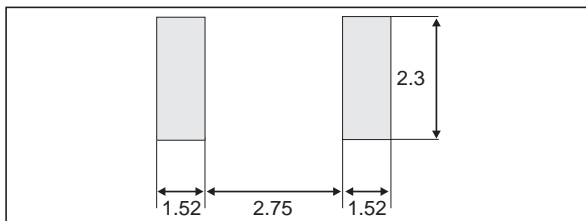
**PACKAGE MECHANICAL DATA**

SMB (Plastic)



**FOOTPRINT DIMENSIONS (Millimeter)**

SMD Plastic.



**Packaging** : standard packaging is in tape and reel.

SOD15 = Standard packaging is in Film.

**Weight** : 0.12 g

Information furnished is believed to be accurate and reliable. However, STMicroelectronics assumes no responsibility for the consequences of use of such information nor for any infringement of patents or other rights of third parties which may result from its use. No license is granted by implication or otherwise under any patent or patent rights of STMicroelectronics. Specifications mentioned in this publication are subject to change without notice. This publication supersedes and replaces all information previously supplied.

STMicroelectronics products are not authorized for use as critical components in life support devices or systems without express written approval of STMicroelectronics.

The ST logo is a registered trademark of STMicroelectronics

© 2001 STMicroelectronics - Printed in Italy - All rights reserved.

STMicroelectronics GROUP OF COMPANIES

Australia - Brazil - China - Finland - France - Germany - Hong Kong - India - Italy - Japan - Malaysia  
 Malta - Morocco - Singapore - Spain - Sweden - Switzerland - United Kingdom - U.S.A.

<http://www.st.com>

