

## LM7301

# Low Power, 4 MHz GBW, Rail-to-Rail Input-Output Operational Amplifier in TinyPak™ Package

### General Description

The LM7301 provides high performance in a wide range of applications. The LM7301 offers greater than rail-to-rail input range, full rail-to-rail output swing, large capacitive load driving ability and low distortion.

With only 0.6 mA supply current, the 4 MHz gain-bandwidth of this device supports new portable applications where higher power devices unacceptably drain battery life.

The LM7301 can be driven by voltages that exceed both power supply rails, thus eliminating concerns over exceeding the common-mode voltage range. The rail-to-rail output swing capability provides the maximum possible dynamic range at the output. This is particularly important when operating on low supply voltages.

Operating on supplies of 1.8V–32V, the LM7301 is excellent for a very wide range of applications in low power systems.

Placing the amplifier right at the signal source reduces board size and simplifies signal routing. The LM7301 fits easily on low profile PCMCIA cards.

### Features

at  $V_S = 5V$  (Typ unless otherwise noted)

- Tiny SOT23-5 package saves space
- Greater than Rail-to-Rail Input CMVR  $-0.25V$  to  $5.25V$
- Rail-to-Rail Output Swing  $0.07V$  to  $4.93V$
- Wide Gain-Bandwidth 4 MHz
- Low Supply Current 0.60 mA
- Wide Supply Range 1.8V to 32V
- High PSRR 104 dB
- High CMRR 93 dB
- Excellent Gain 97 dB

### Applications

- Portable instrumentation
- Signal conditioning amplifiers/ADC buffers
- Active filters
- Modems
- PCMCIA cards

### Connection Diagrams

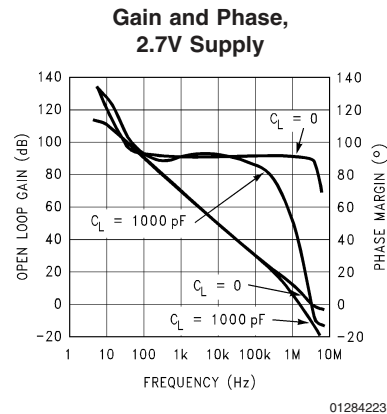
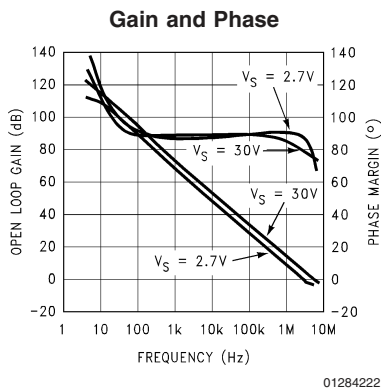
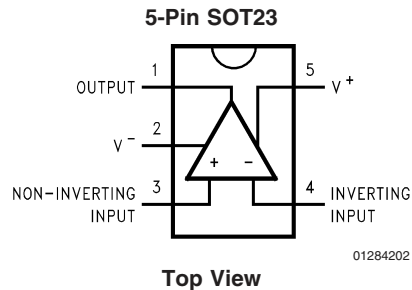
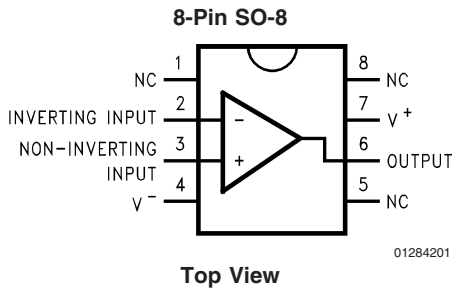

**Absolute Maximum Ratings** (Note 1)

If Military/Aerospace specified devices are required, please contact the National Semiconductor Sales Office/Distributors for availability and specifications.

ESD Tolerance (Note 2)	2500V
Differential Input Voltage	15V
Voltage at Input/Output Pin	(V <sup>+</sup> ) + 0.3V, (V <sup>-</sup> ) -0.3V
Supply Voltage (V <sup>+</sup> - V <sup>-</sup> )	35V
Current at Input Pin	±10 mA
Current at Output Pin (Note 3)	±20 mA
Current at Power Supply Pin	25 mA
Lead Temperature	

(Soldering, 10 sec.)

Storage Temperature Range	-65°C to +150°C
Junction Temperature (Note 4)	150°C

**Operating Ratings** (Note 1)

Supply Voltage	1.8V ≤ V <sub>S</sub> ≤ 32V
Junction Temperature Range	-40°C ≤ T <sub>J</sub> ≤ +85°C
Thermal Resistance (θ <sub>JA</sub> )	
M5 Package, 5-Pin SOT23	325°C/W
M Package,	
8-Pin Surface Mount	165°C/W

**5.0V DC Electrical Characteristics**

Unless otherwise specified, all limits guaranteed for T<sub>J</sub> = 25°C, V<sup>+</sup> = 5.0V, V<sup>-</sup> = 0V, V<sub>CM</sub> = V<sub>O</sub> = V<sup>+</sup>/2 and R<sub>L</sub> > 1 MΩ to V<sup>+</sup>/2. **Boldface** limits apply at the temperature extremes

Symbol	Parameter	Conditions	Typ (Note 5)	LM7301 Limit (Note 6)	Units
V <sub>OS</sub>	Input Offset Voltage		0.03	6 <b>8</b>	mV max
TCV <sub>OS</sub>	Input Offset Voltage Average Drift		<b>2</b>		μV/°C
I <sub>B</sub>	Input Bias Current	V <sub>CM</sub> = 0V	90	200 <b>250</b>	nA max
		V <sub>CM</sub> = 5V	-40	-75 <b>-85</b>	nA min
I <sub>OS</sub>	Input Offset Current	V <sub>CM</sub> = 0V	0.7	70 <b>80</b>	nA max
		V <sub>CM</sub> = 5V	0.7	55 <b>65</b>	
R <sub>IN</sub>	Input Resistance, CM	0V ≤ V <sub>CM</sub> ≤ 5V	39		MΩ
CMRR	Common Mode Rejection Ratio	0V ≤ V <sub>CM</sub> ≤ 5V	88	70 <b>67</b>	dB min
		0V ≤ V <sub>CM</sub> ≤ 3.5V	93		
PSRR	Power Supply Rejection Ratio	2.2V ≤ V <sup>+</sup> ≤ 30V	104	87 <b>84</b>	
V <sub>CM</sub>	Input Common-Mode Voltage Range	CMRR ≥ 65 dB	5.1		V
			-0.1		V
A <sub>V</sub>	Large Signal Voltage Gain	R <sub>L</sub> = 10 kΩ V <sub>O</sub> = 4.0V <sub>PP</sub>	71	14 <b>10</b>	V/mV min
V <sub>O</sub>	Output Swing	R <sub>L</sub> = 10 kΩ	0.07	0.12 <b>0.15</b>	V max
			4.93	4.88 <b>4.85</b>	V min
		R <sub>L</sub> = 2 kΩ	0.14	0.20 <b>0.22</b>	V max
			4.87	4.80 <b>4.78</b>	V min
I <sub>SC</sub>	Output Short Circuit Current	Sourcing	11.0	8.0 <b>5.5</b>	mA min
		Sinking	9.5	6.0 <b>5.0</b>	mA min

## 5.0V DC Electrical Characteristics (Continued)

Unless otherwise specified, all limits guaranteed for  $T_J = 25^\circ\text{C}$ ,  $V^+ = 5.0\text{V}$ ,  $V^- = 0\text{V}$ ,  $V_{\text{CM}} = V_O = V^+/2$  and  $R_L > 1\text{ M}\Omega$  to  $V^+/2$ .

**Boldface** limits apply at the temperature extremes

Symbol	Parameter	Conditions	Typ (Note 5)	LM7301 Limit (Note 6)	Units
$I_S$	Supply Current		0.60	1.10 <b>1.24</b>	mA max

## AC Electrical Characteristics

$T_J = 25^\circ\text{C}$ ,  $V^+ = 2.2\text{V}$  to  $30\text{V}$ ,  $V^- = 0\text{V}$ ,  $V_{\text{CM}} = V_O = V^+/2$  and  $R_L > 1\text{ M}\Omega$  to  $V^+/2$

Symbol	Parameter	Conditions	Typ (Note 5)	Units
SR	Slew Rate	$\pm 4\text{V Step @ } V_S \pm 6\text{V}$	1.25	V/ $\mu\text{s}$
GBW	Gain-Bandwidth Product	$f = 100\text{ kHz}$ , $R_L = 10\text{ k}\Omega$	4	MHz
$e_n$	Input-Referred Voltage Noise	$f = 1\text{ kHz}$	36	$\frac{\text{nV}}{\sqrt{\text{Hz}}}$
$i_n$	Input-Referred Current Noise	$f = 1\text{ kHz}$	0.24	$\frac{\text{pA}}{\sqrt{\text{Hz}}}$
T.H.D.	Total Harmonic Distortion	$f = 10\text{ kHz}$	0.006	%

## 2.2V DC Electrical Characteristics

Unless otherwise specified, all limits guaranteed for  $T_J = 25^\circ\text{C}$ ,  $V^+ = 2.2\text{V}$ ,  $V^- = 0\text{V}$ ,  $V_{\text{CM}} = V_O = V^+/2$  and  $R_L > 1\text{ M}\Omega$  to  $V^+/2$ .

**Boldface** limits apply at the temperature extremes

Symbol	Parameter	Conditions	Typ (Note 5)	LM7301 Limit (Note 6)	Units
$V_{\text{OS}}$	Input Offset Voltage		0.04	6 <b>8</b>	mV max
$\text{TCV}_{\text{OS}}$	Input Offset Voltage Average Drift		<b>2</b>		$\mu\text{V}/^\circ\text{C}$
$I_B$	Input Bias Current	$V_{\text{CM}} = 0\text{V}$	89	200 <b>250</b>	nA max
		$V_{\text{CM}} = 2.2\text{V}$	-35	-75 <b>-85</b>	nA min
$I_{\text{OS}}$	Input Offset Current	$V_{\text{CM}} = 0\text{V}$	0.8	70 <b>80</b>	nA max
		$V_{\text{CM}} = 2.2\text{V}$	0.4	55 <b>65</b>	
$R_{\text{IN}}$	Input Resistance	$0\text{V} \leq V_{\text{CM}} \leq 2.2\text{V}$	18		$\text{M}\Omega$
CMRR	Common Mode Rejection Ratio	$0\text{V} \leq V_{\text{CM}} \leq 2.2\text{V}$	82	60 <b>56</b>	dB min
		$2.2\text{V} \leq V^+ \leq 30\text{V}$	104	87 <b>84</b>	
$V_{\text{CM}}$	Input Common-Mode Voltage Range	CMRR > 60 dB	2.3		V
			-0.1		V
$A_V$	Large Signal Voltage Gain	$R_L = 10\text{ k}\Omega$ $V_O = 1.6V_{\text{PP}}$	46	6.5 <b>5.4</b>	V/mV min

## 2.2V DC Electrical Characteristics (Continued)

Unless otherwise specified, all limits guaranteed for  $T_J = 25^\circ\text{C}$ ,  $V^+ = 2.2\text{V}$ ,  $V^- = 0\text{V}$ ,  $V_{\text{CM}} = V_O = V^+/2$  and  $R_L > 1\text{ M}\Omega$  to  $V^+/2$ .

**Boldface** limits apply at the temperature extremes

Symbol	Parameter	Conditions	Typ (Note 5)	LM7301 Limit (Note 6)	Units
$V_O$	Output Swing	$R_L = 10\text{ k}\Omega$	0.05	0.08 <b>0.10</b>	V max
			2.15	2.10 <b>2.00</b>	V min
		$R_L = 2\text{ k}\Omega$	0.09	0.13 <b>0.14</b>	V max
			2.10	2.07 <b>2.00</b>	V min
$I_{\text{SC}}$	Output Short Circuit Current	Sourcing	10.9	8.0 <b>5.5</b>	mA min
		Sinking	7.7	6.0 <b>5.0</b>	mA min
$I_S$	Supply Current		0.57	0.97 <b>1.24</b>	mA max

## 30V DC Electrical Characteristics

Unless otherwise specified, all limits guaranteed for  $T_J = 25^\circ\text{C}$ ,  $V^+ = 30\text{V}$ ,  $V^- = 0\text{V}$ ,  $V_{\text{CM}} = V_O = V^+/2$  and  $R_L > 1\text{ M}\Omega$  to  $V^+/2$ .

**Boldface** limits apply at the temperature extremes

Symbol	Parameter	Conditions	Typ (Note 5)	LM7301 Limit (Note 6)	Units
$V_{\text{OS}}$	Input Offset Voltage		0.04	6 <b>8</b>	mV max
$\text{TCV}_{\text{OS}}$	Input Offset Voltage Average Drift		<b>2</b>		$\mu\text{V}/^\circ\text{C}$
$I_B$	Input Bias Current	$V_{\text{CM}} = 0\text{V}$	103	300 <b>500</b>	nA max
		$V_{\text{CM}} = 30\text{V}$	-50	-100 <b>-200</b>	nA min
$I_{\text{OS}}$	Input Offset Current	$V_{\text{CM}} = 0\text{V}$	1.2	90 <b>190</b>	nA max
		$V_{\text{CM}} = 30\text{V}$	0.5	65 <b>135</b>	nA max
$R_{\text{IN}}$	Input Resistance	$0\text{V} \leq V_{\text{CM}} \leq 30\text{V}$	200		$\text{M}\Omega$
CMRR	Common Mode Rejection Ratio	$0\text{V} \leq V_{\text{CM}} \leq 30\text{V}$	104	80 <b>78</b>	dB min
		$0\text{V} \leq V_{\text{CM}} \leq 27\text{V}$	115	90 <b>88</b>	
PSRR	Power Supply Rejection Ratio	$2.2\text{V} \leq V^+ \leq 30\text{V}$	104	87 <b>84</b>	
$V_{\text{CM}}$	Input Common-Mode Voltage Range	CMRR > 80 dB	30.1		V
			-0.1		V
$A_V$	Large Signal Voltage Gain	$R_L = 10\text{ k}\Omega$ $V_O = 28V_{\text{PP}}$	105	30 <b>20</b>	V/mV min

## 30V DC Electrical Characteristics (Continued)

Unless otherwise specified, all limits guaranteed for  $T_J = 25^\circ\text{C}$ ,  $V^+ = 30\text{V}$ ,  $V^- = 0\text{V}$ ,  $V_{\text{CM}} = V_O = V^+/2$  and  $R_L > 1\text{ M}\Omega$  to  $V^+/2$ .

**Boldface** limits apply at the temperature extremes

Symbol	Parameter	Conditions	Typ (Note 5)	LM7301 Limit (Note 6)	Units
$V_O$	Output Swing	$R_L = 10\text{ k}\Omega$	0.16	0.275 <b>0.375</b>	V max
			29.8	29.75 <b>28.65</b>	V min
$I_{\text{SC}}$	Output Short Circuit Current	Sourcing (Note 4)	11.7	8.8 <b>6.5</b>	mA min
		Sinking (Note 4)	11.5	8.2 <b>6.0</b>	mA min
$I_S$	Supply Current		0.72	1.30 <b>1.35</b>	mA max

**Note 1:** Absolute Maximum Ratings indicate limits beyond which damage to the device may occur. Operating Ratings indicate conditions for which the device is intended to be functional, but specific performance is not guaranteed. For guaranteed specifications and the test conditions, see the Electrical Characteristics.

**Note 2:** Human body model, 1.5 k $\Omega$  in series with 100 pF.

**Note 3:** Applies to both single-supply and split-supply operation. Continuous short circuit operation at elevated ambient temperature can result in exceeding the maximum allowed junction temperature of 150 $^\circ\text{C}$ .

**Note 4:** The maximum power dissipation is a function of  $T_{J(\text{max})}$ ,  $\theta_{\text{JA}}$ , and  $T_A$ . The maximum allowable power dissipation at any ambient temperature is  $P_D = (T_{J(\text{max})} - T_A)/\theta_{\text{JA}}$ . All numbers apply for packages soldered directly into a PC board.

**Note 5:** Typical Values represent the most likely parametric norm.

**Note 6:** All limits are guaranteed by testing or statistical analysis.

## Typical Performance Characteristics

$T_A = 25^\circ\text{C}$ ,  $R_L = 1\text{ M}\Omega$  unless otherwise specified

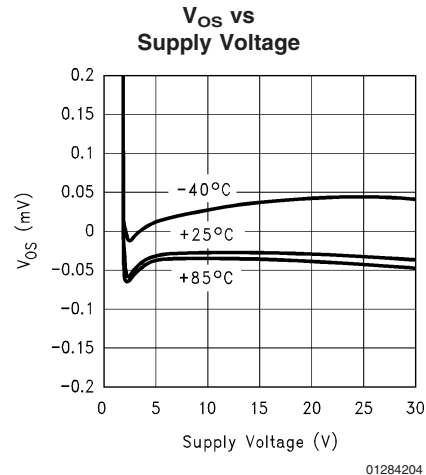
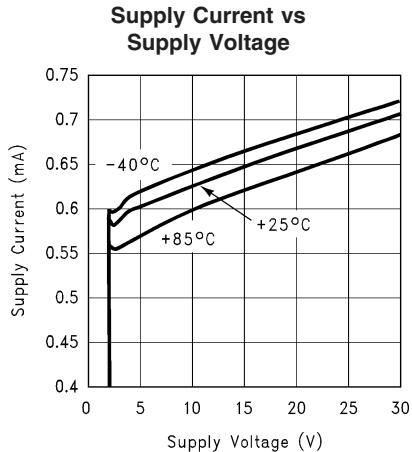

**Typical Performance Characteristics**  $T_A = 25^\circ\text{C}$ ,  $R_L = 1\text{ M}\Omega$  unless otherwise specified (Continued)

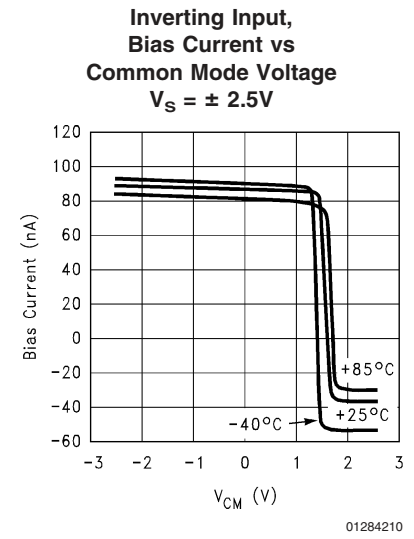
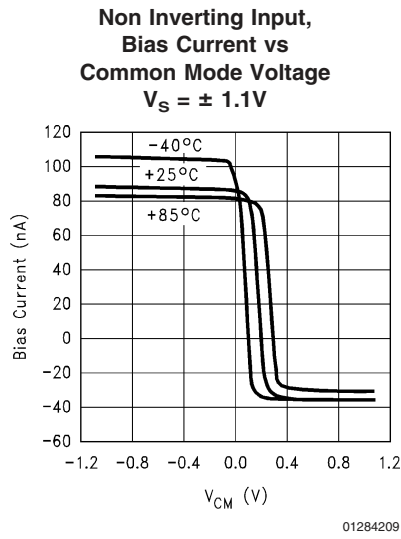
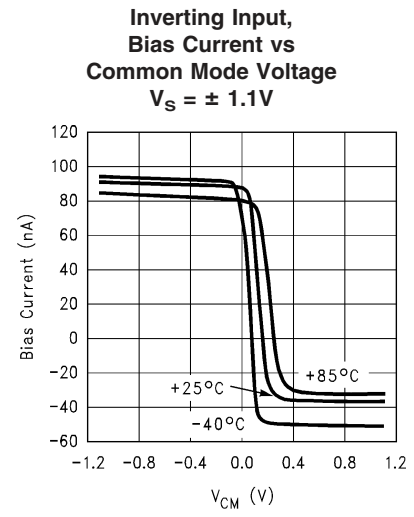
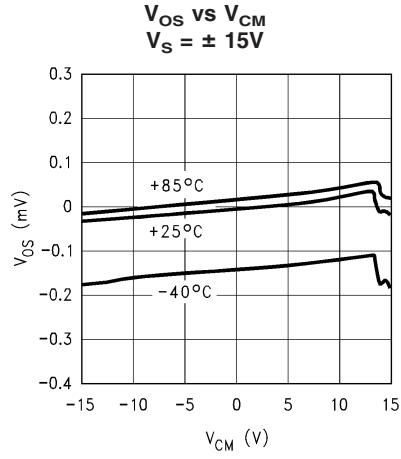
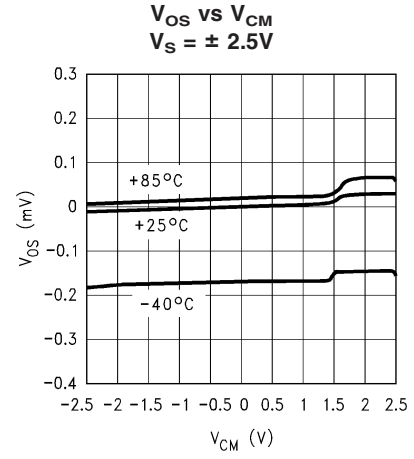
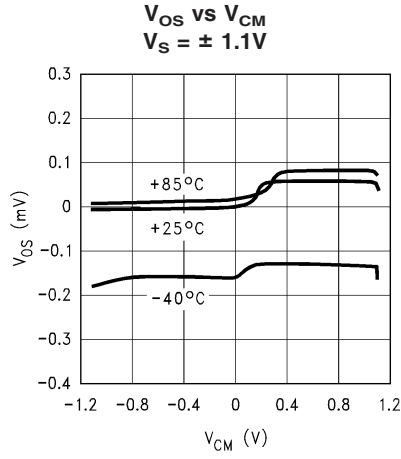

**Typical Performance Characteristics**  $T_A = 25^\circ\text{C}$ ,  $R_L = 1\text{ M}\Omega$  unless otherwise specified (Continued)

**Non Inverting Input,  
Bias Current vs  
Common Mode Voltage**  
 $V_S = \pm 2.5\text{V}$

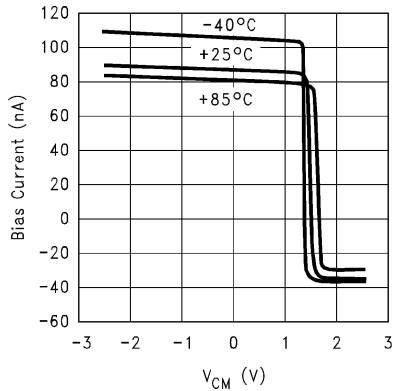

01284211

**Non Inverting Input,  
Bias Current vs  
Common Mode Voltage**  
 $V_S = \pm 15\text{V}$

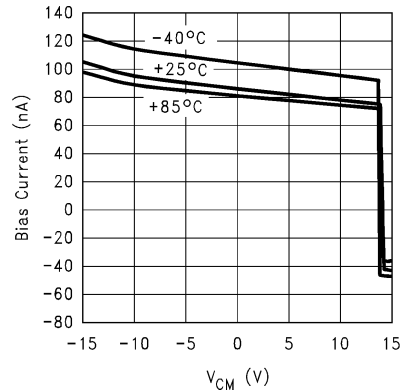

01284212

**Inverting Input,  
Bias Current vs  
Common Mode Voltage**  
 $V_S = \pm 15\text{V}$

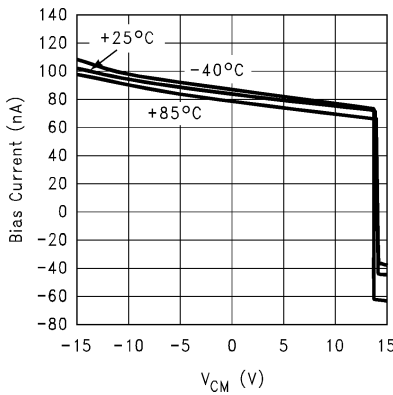

01284213

**$V_O$  vs  $I_O$ ,  $V_S = \pm 1.1\text{V}$**

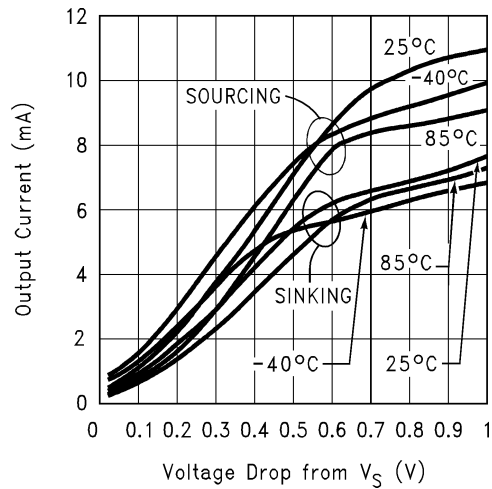

01284224

**$V_O$  vs  $I_O$ ,  $V_S = \pm 2.5\text{V}$**

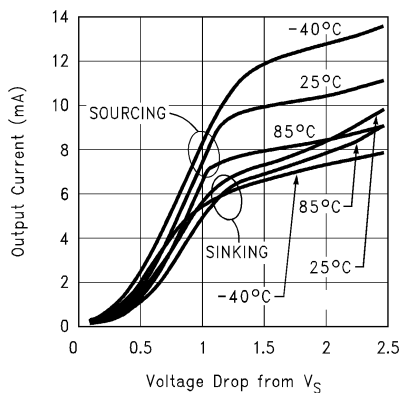

01284225

**Short Circuit Current  
vs Supply Voltage**

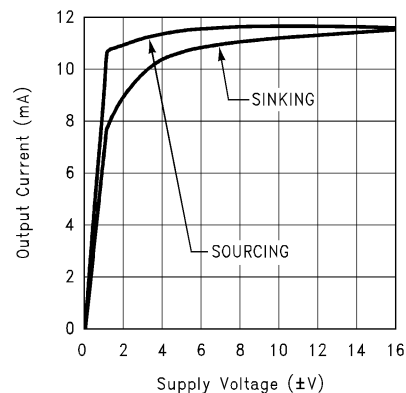

01284226

## Typical Performance Characteristics $T_A = 25^\circ\text{C}$ , $R_L = 1\text{ M}\Omega$ unless otherwise specified (Continued)

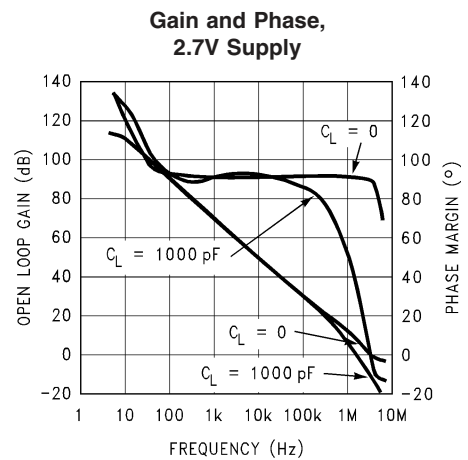
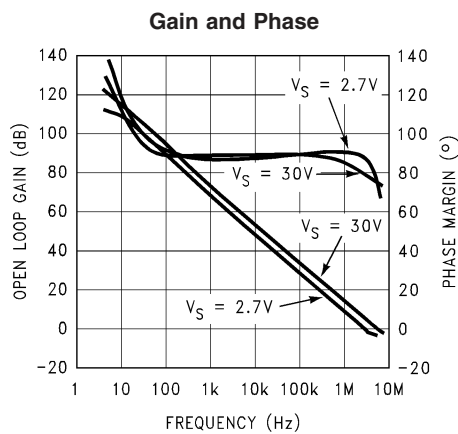
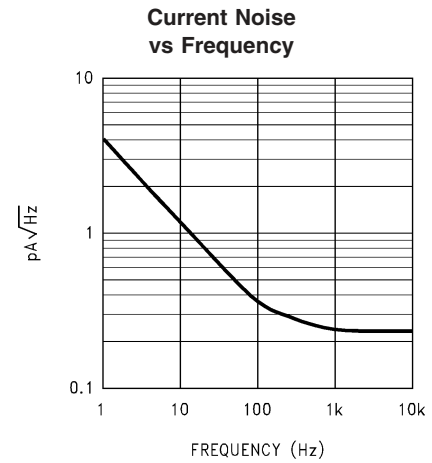
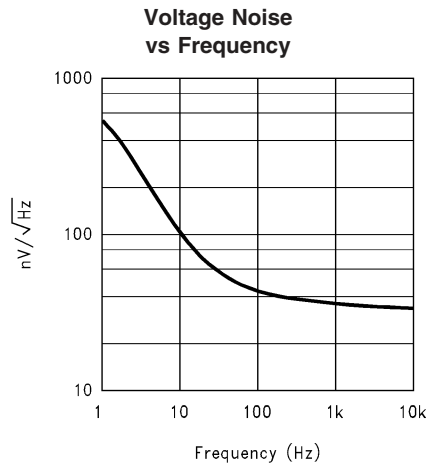

## Applications Information

### GENERAL INFORMATION

Low supply current and wide bandwidth, greater than rail-to-rail input range, full rail-to-rail output, good capacitive load driving ability, wide supply voltage and low distortion all make the LM7301 ideal for many diverse applications.

The high common-mode rejection ratio and full rail-to-rail input range provides precision performance when operated in noninverting applications where the common-mode error is added directly to the other system errors.

### CAPACITIVE LOAD DRIVING

The LM7301 has the ability to drive large capacitive loads. For example, 1000 pF only reduces the phase margin to about 25 degrees.

### TRANSIENT RESPONSE

The LM7301 offers a very clean, well-behaved transient response. *Figures 1, 2, 3, 4, 5, 6* show the response when operated at gains of +1 and -1 when handling both small and large signals. The large phase margin, typically 70 to 80 degrees, assures clean and symmetrical response. In the large signal scope photos, *Figure 1* and *Figure 4*, the input signal is set to 4.8V. Note that the output goes to within 100 mV of the supplies cleanly and without overshoot. In the

small signal samples, the response is clean, with only slight overshoot when used as a follower. *Figure 3* and *Figure 6* are the circuits used to make these photos.

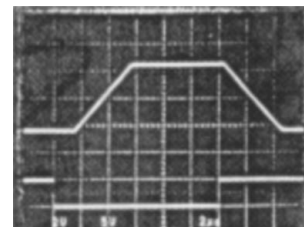
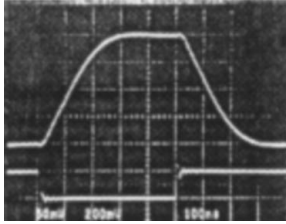

FIGURE 1.



## Applications Information (Continued)



01284217

FIGURE 2.

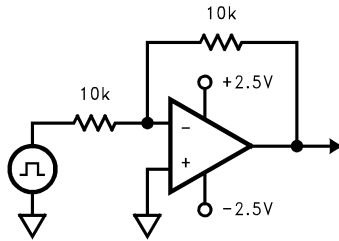

01284218

FIGURE 3.

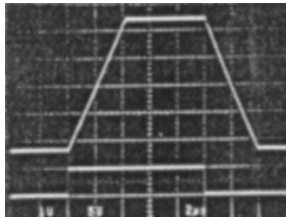

01284219

FIGURE 4.

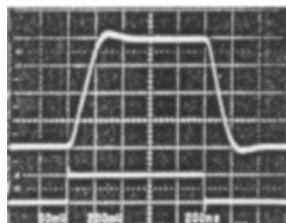

01284220

FIGURE 5.

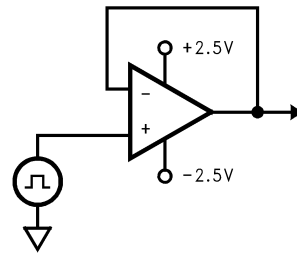

01284221

FIGURE 6.

### POWER DISSIPATION

Although the LM7301 has internal output current limiting, shorting the output to ground when operating on a +30V power supply will cause the opamp to dissipate about 350 mW. This is a worst-case example. In the SO-8 package, this will cause a temperature rise of 58°C. In the SOT23-5 package, the higher thermal resistance will cause a calculated rise of 113°C. This can raise the junction temperature to above the absolute maximum temperature of 150°C.

Operating from split supplies greatly reduces the power dissipated when the output is shorted. Operating on  $\pm 15\text{V}$  supplies can only cause a temperature rise of 29°C in the SO-8 and 57°C in the SOT23-5 package, assuming the short is to ground.

### SPICE Macromodel

A SPICE macromodel for this and many other National Semiconductor operational amplifiers is available, at no charge, from the NSC Customer Support Center at 800-272-9959 or on the World Wide Web at <http://www.national.com/models>.

### WIDE SUPPLY RANGE

The high power-supply rejection ratio (PSRR) and common-mode rejection ratio (CMRR) provide precision performance when operated on battery or other unregulated supplies. This advantage is further enhanced by the very wide supply range (2.2V–30V, guaranteed) offered by the LM7301. In situations where highly variable or unregulated supplies are present, the excellent PSRR and wide supply range of the LM7301 benefit the system designer with continued precision performance, even in such adverse supply conditions.

### SPECIFIC ADVANTAGES OF SOT23-5 (TinyPak)

The obvious advantage of the SOT23-5, TinyPak, is that it can save board space, a critical aspect of any portable or miniaturized system design. The need to decrease overall system size is inherent in any handheld, portable, or light-weight system application.

Furthermore, the low profile can help in height limited designs, such as consumer hand-held remote controls, sub-notebook computers, and PCMCIA cards.

An additional advantage of the tiny package is that it allows better system performance due to ease of package placement. Because the tiny package is so small, it can fit on the board right where the opamp needs to be placed for optimal performance, unconstrained by the usual space limitations. This optimal placement of the tiny package allows for many system enhancements, not easily achieved with the con-

## Applications Information (Continued)

straints of a larger package. For example, problems such as system noise due to undesired pickup of digital signals can be easily reduced or mitigated. This pick-up problem is often caused by long wires in the board layout going to or from an opamp. By placing the tiny package closer to the signal source and allowing the LM7301 output to drive the long wire, the signal becomes less sensitive to such pick-up. An overall reduction of system noise results.

Often times system designers try to save space by using dual or quad opamps in their board layouts. This causes a complicated board layout due to the requirement of routing several signals to and from the same place on the board. Using the tiny opamp eliminates this problem.

Additional space savings parts are available in tiny packages from National Semiconductor, including low power amplifiers, precision voltage references, and voltage regulators.

### LOW DISTORTION, HIGH OUTPUT DRIVE CAPABILITY

The LM7301 offers superior low-distortion performance, with a total-harmonic-distortion-plus-noise of 0.06% at  $f = 10$  kHz. The advantage offered by the LM7301 is its low distortion levels, even at high output current and low load resistance.

## Typical Applications

### HANDHELD REMOTE CONTROLS

The LM7301 offers outstanding specifications for applications requiring good speed/power trade-off. In applications such as remote control operation, where high bandwidth and low power consumption are needed. The LM7301 performance can easily meet these requirements.

## Ordering Information

Package	Ordering Information	NSC Drawing Number	Package Marking	Supplied As
8-Pin SO-8	LM7301IMX	M08A	LM7301IM	2.5k Tape and Reel Rails
	LM7301IM	M08A	LM7301IM	
5-Pin SOT23	LM7301IM5	MA05A	A04A	1k Tape and Reel
	LM7301IM5X	MA05A	A04A	3k Tape and Reel

### OPTICAL LINE ISOLATION FOR MODEMS

The combination of the low distortion and good load driving capabilities of the LM7301 make it an excellent choice for driving opto-coupler circuits to achieve line isolation for modems. This technique prevents telephone line noise from coupling onto the modem signal. Superior isolation is achieved by coupling the signal optically from the computer modem to the telephone lines; however, this also requires a low distortion at relatively high currents. Due to its low distortion at high output drive currents, the LM7301 fulfills this need, in this and in other telecom applications.

### REMOTE MICROPHONE IN PERSONAL COMPUTERS

Remote microphones in Personal Computers often utilize a microphone at the top of the monitor which must drive a long cable in a high noise environment. One method often used to reduce the noise is to lower the signal impedance, which reduces the noise pickup. In this configuration, the amplifier usually requires 30 db–40 db of gain, at bandwidths higher than most low-power CMOS parts can achieve. The LM7301 offers the tiny package, higher bandwidths, and greater output drive capability than other rail-to-rail input/output parts can provide for this application.

**Physical Dimensions** inches (millimeters)

unless otherwise noted

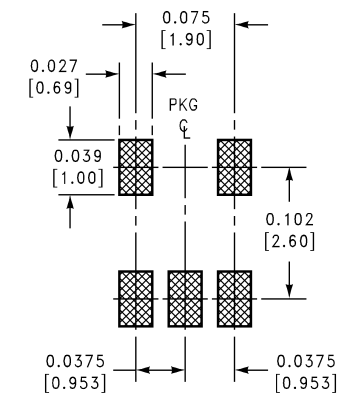
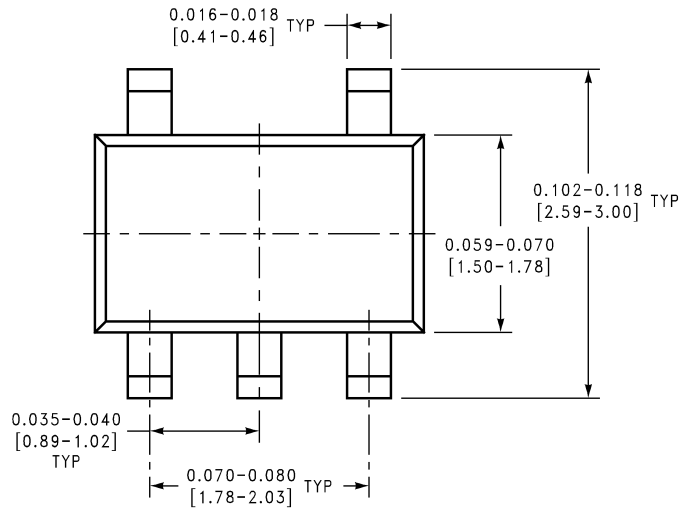

LAND PATTERN RECOMMENDATION

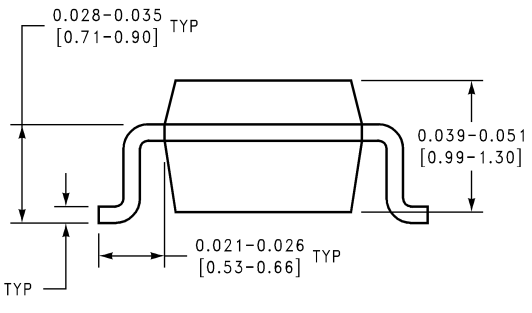
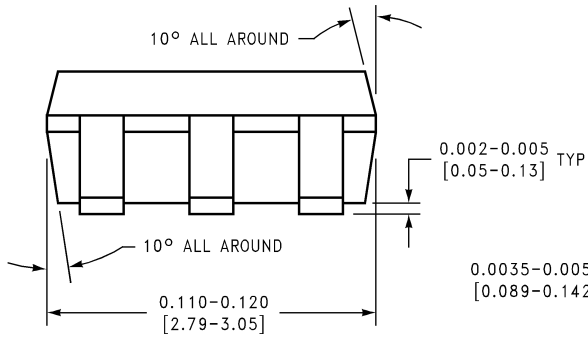

MA05A (REV D)

**5-Pin SOT-23 Package**  
**Order Number LM7301IM5X or LM7301IM5**  
**NS Package Number MA05A**

**Physical Dimensions** inches (millimeters) unless otherwise noted (Continued)

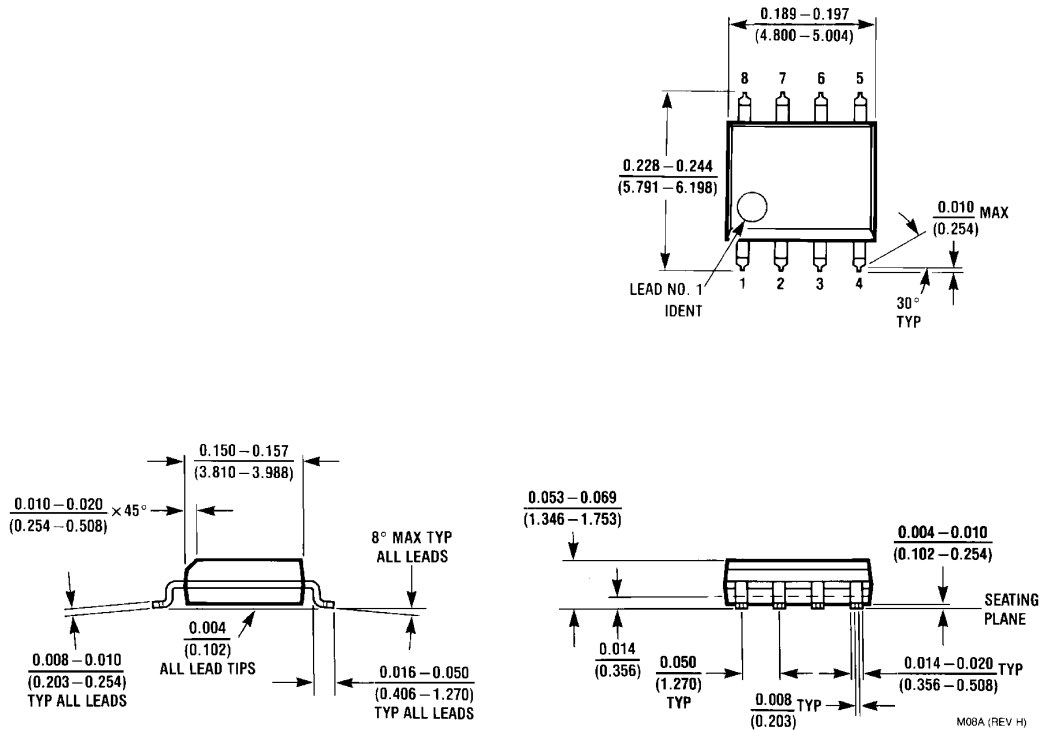

**8-Pin Small Outline Package**  
**Order Number LM7301IM or LM7301IMX**  
**NS Package Number M08A**

National does not assume any responsibility for use of any circuitry described, no circuit patent licenses are implied and National reserves the right at any time without notice to change said circuitry and specifications.

For the most current product information visit us at [www.national.com](http://www.national.com).

**LIFE SUPPORT POLICY**

NATIONAL'S PRODUCTS ARE NOT AUTHORIZED FOR USE AS CRITICAL COMPONENTS IN LIFE SUPPORT DEVICES OR SYSTEMS WITHOUT THE EXPRESS WRITTEN APPROVAL OF THE PRESIDENT AND GENERAL COUNSEL OF NATIONAL SEMICONDUCTOR CORPORATION. As used herein:

1. Life support devices or systems are devices or systems which, (a) are intended for surgical implant into the body, or (b) support or sustain life, and whose failure to perform when properly used in accordance with instructions for use provided in the labeling, can be reasonably expected to result in a significant injury to the user.
2. A critical component is any component of a life support device or system whose failure to perform can be reasonably expected to cause the failure of the life support device or system, or to affect its safety or effectiveness.

**BANNED SUBSTANCE COMPLIANCE**

National Semiconductor certifies that the products and packing materials meet the provisions of the Customer Products Stewardship Specification (CSP-9-111C2) and the Banned Substances and Materials of Interest Specification (CSP-9-111S2) and contain no "Banned Substances" as defined in CSP-9-111S2.

 **National Semiconductor**  
**Americas Customer Support Center**  
 Email: [new.feedback@nsc.com](mailto:new.feedback@nsc.com)  
 Tel: 1-800-272-9959

**National Semiconductor**  
**Europe Customer Support Center**  
 Fax: +49 (0) 180-530 85 86  
 Email: [europe.support@nsc.com](mailto:europe.support@nsc.com)  
 Deutsch Tel: +49 (0) 69 9508 6208  
 English Tel: +44 (0) 870 24 0 2171  
 Français Tel: +33 (0) 1 41 91 8790

**National Semiconductor**  
**Asia Pacific Customer Support Center**  
 Email: [ap.support@nsc.com](mailto:ap.support@nsc.com)

**National Semiconductor**  
**Japan Customer Support Center**  
 Fax: 81-3-5639-7507  
 Email: [jpn.feedback@nsc.com](mailto:jpn.feedback@nsc.com)  
 Tel: 81-3-5639-7560

This datasheet has been download from:

[www.datasheetcatalog.com](http://www.datasheetcatalog.com)

Datasheets for electronics components.